



5STP 06T1600

Old part no. T 906C-640-16

Phase Control Thyristor

Properties

- High operational capability
- Possibility of serial and parallel connection

Applications

- Controlled rectifiers
- AC drives

Key Parameters

V_{DRM}, V_{RRM}	= 1 600	V
I_{TAVm}	= 641	A
I_{TSM}	= 9 900	A
V_{TO}	= 0.990	V
r_T	= 0.503	mΩ

Types

	V_{RRM}, V_{DRM}
5STP 06T1600	1 600 V
Conditions:	$T_j = -40 \div 125 \text{ }^\circ\text{C}$, half sine waveform, $f = 50 \text{ Hz}$

Mechanical Data

F_m	Mounting force	$9 \pm 3 \text{ kN}$
m	Weight	0.11 kg
D_s	Surface creepage distance	12.2 mm
D_a	Air strike distance	5.5 mm

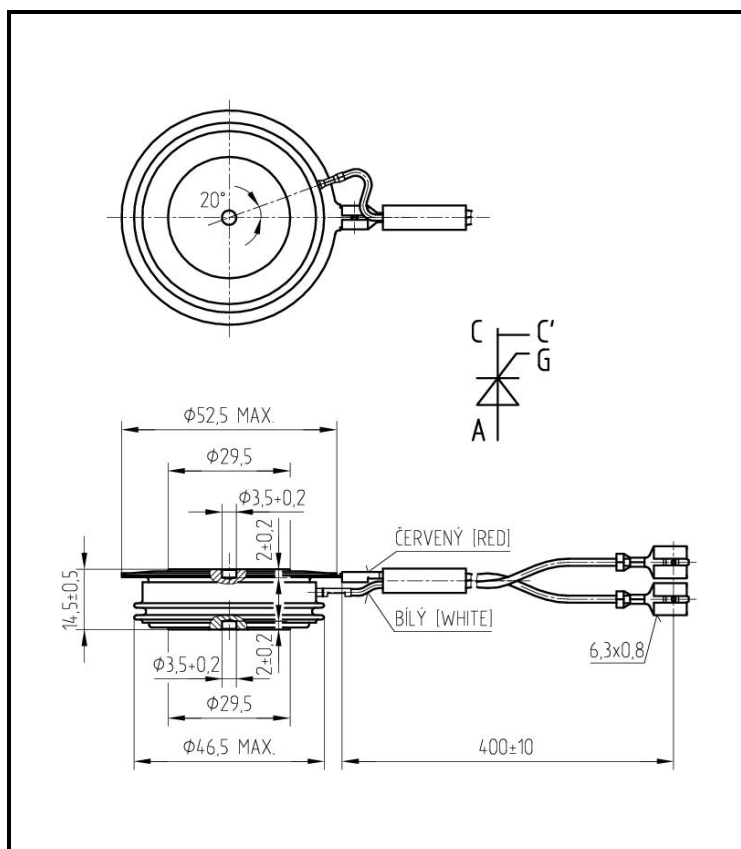

Fig. 1 Case



ABB s.r.o.

Novodvorska 1768/138a, 142 21 Praha 4, Czech Republic

tel.: +420 261 306 250, <http://www.abb.com/semiconductors>

Maximum Ratings		Maximum Limits	Unit
V_{RRM} V_{DRM}	Repetitive peak reverse and off-state voltage $T_j = -40 \div 125 \text{ }^\circ\text{C}$	1 600	V
I_{TRMS}	RMS on-state current $T_c = 70 \text{ }^\circ\text{C}$, half sine waveform, $f = 50 \text{ Hz}$	1 007	A
I_{TAVm}	Average on-state current $T_c = 70 \text{ }^\circ\text{C}$, half sine waveform, $f = 50 \text{ Hz}$	641	A
I_{TSM}	Peak non-repetitive surge half sine pulse, $V_R = 0 \text{ V}$	$t_p = 10 \text{ ms}$ 9 900	A
		$t_p = 8.3 \text{ ms}$ 10 600	
I_{TSM}	Peak non-repetitive surge half sine pulse, $V_R = 0.7 V_{RRM}$	$t_p = 10 \text{ ms}$ 7 900	A
		$t_p = 8.3 \text{ ms}$ 8 500	
$\int i^2 t$	Limiting load integral half sine pulse, $V_R = 0 \text{ V}$	$t_p = 10 \text{ ms}$ 490 000	A²s
		$t_p = 8.3 \text{ ms}$ 470 000	
$\int i^2 t$	Limiting load integral half sine pulse, $V_R = 0.7 V_{RRM}$	$t_p = 10 \text{ ms}$ 314 000	A²s
		$t_p = 8.3 \text{ ms}$ 300 000	
$(di_T/dt)_{cr}$	Critical rate of rise of on-state current $I_T = I_{TAVm}$, half sine waveform, $f = 50 \text{ Hz}$, $V_D = 2/3 V_{DRM}$, $t_r = 0.3 \mu\text{s}$, $I_{GT} = 2 \text{ A}$	200	A/μs
$(dv_D/dt)_{cr}$	Critical rate of rise of off-state voltage $V_D = 2/3 V_{DRM}$	1 000	V/μs
P_{GAVm}	Maximum average gate power losses	3	W
I_{FGM}	Peak gate current	10	A
V_{FGM}	Peak gate voltage	12	V
V_{RGM}	Reverse peak gate voltage	10	V
$T_{jmin} - T_{jmax}$	Operating temperature range	-40 \div 125	$^\circ\text{C}$
$T_{stgmin} - T_{stgmax}$	Storage temperature range	-40 \div 125	$^\circ\text{C}$

Unless otherwise specified $T_j = 125 \text{ }^\circ\text{C}$

Characteristics		Value			Unit
		min.	typ.	max.	
V_{TM}	Maximum peak on-state voltage $I_{TM} = 1\ 000\ A$			1.500	V
V_{TO}	Threshold voltage			0.990	V
r_T	Slope resistance $I_{T1} = 800\ A, I_{T2} = 2\ 399\ A$			0.503	mΩ
I_{DM}	Peak off-state current $V_D = V_{DRM}$			30	mA
I_{RM}	Peak reverse current $V_R = V_{RRM}$			30	mA
t_{gd}	Delay time $T_j = 25\ ^\circ C, V_D = 0.4\ V_{DRM}, I_{TM} = I_{TAVm},$ $t_r = 0.3\ \mu s, I_{GT} = 2\ A$			2	μs
t_q	Turn-off time $I_T = 640\ A, di_T/dt = 12.5\ A/\mu s,$ $V_D = 2/3\ V_{DRM}, dv_D/dt = 50\ V/\mu s$		150		μs
Q_{rr}	Recovery charge <i>the same conditions as at t_q</i>		1 000		μC
I_H	Holding current	$T_j = 25\ ^\circ C$ $T_j = 125\ ^\circ C$		150 80	mA
I_L	Latching current	$T_j = 25\ ^\circ C$ $T_j = 125\ ^\circ C$		500 350	mA
V_{GT}	Gate trigger voltage $V_D = 12\ V, I_T = 4\ A$	$T_j = -40\ ^\circ C$ $T_j = 25\ ^\circ C$ $T_j = 125\ ^\circ C$	0.25	4 3 2	V
I_{GT}	Gate trigger current $V_D = 12\ V, I_T = 4\ A$	$T_j = -40\ ^\circ C$ $T_j = 25\ ^\circ C$ $T_j = 125\ ^\circ C$	10	500 250 150	mA

Unless otherwise specified $T_j = 125\ ^\circ C$

Thermal Parameters		Value	Unit
R_{thjc}	Thermal resistance junction to case <i>double side cooling</i>	44.0	K/kW
	<i>anode side cooling</i>	70.0	
	<i>cathode side cooling</i>	118.0	
R_{thch}	Thermal resistance case to heatsink <i>double side cooling</i>	12.0	K/kW
	<i>single side cooling</i>	24.0	

Transient Thermal Impedance						
Analytical function for transient thermal impedance $Z_{thjc} = \sum_{i=1}^5 R_i (1 - \exp(-t / \tau_i))$	i	1	2	3	4	5
	R_i (K/kW)	28.28	10.76	1.26	3.47	0.16
	τ_i (s)	0.2340	0.0859	0.0157	0.0037	0.0007
Conditions: $F_m = 9 \pm 3$ kN, Double side cooled						
Correction for periodic waveforms 180° sine: add 4.0 K/kW 180° rectangular: add 6.0 K/kW 120° rectangular: add 9.0 K/kW 60° rectangular: add 15.5 K/kW						
<p>Fig. 2 Dependence transient thermal impedance junction to case on square pulse</p>						

Maximum On-state Characteristics

Analytical function for on-state characteristics:

$$v = A + B \cdot i + C \cdot \sqrt{i} + D \cdot \ln(i+1)$$

Conditions:

$$F_m = 9 \pm 3 \text{ kN,}$$

half sine pulse 8.3/10 ms

T_j (°C)	A	B	C	D
25	6.739E-1	3.730E-4	-2.519E-3	7.669E-2
125	5.754E-1	5.005E-4	-4.021E-3	7.925E-2

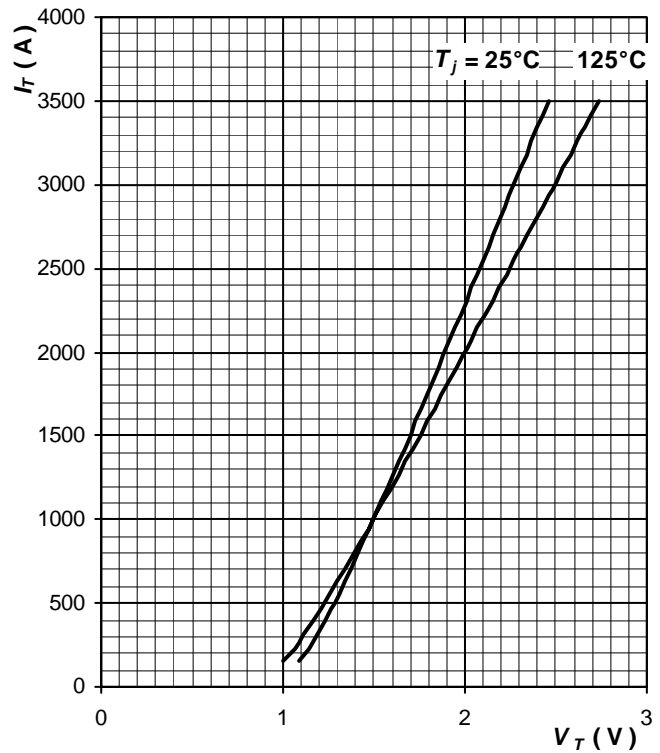

Fig. 3 Maximum on-state characteristics

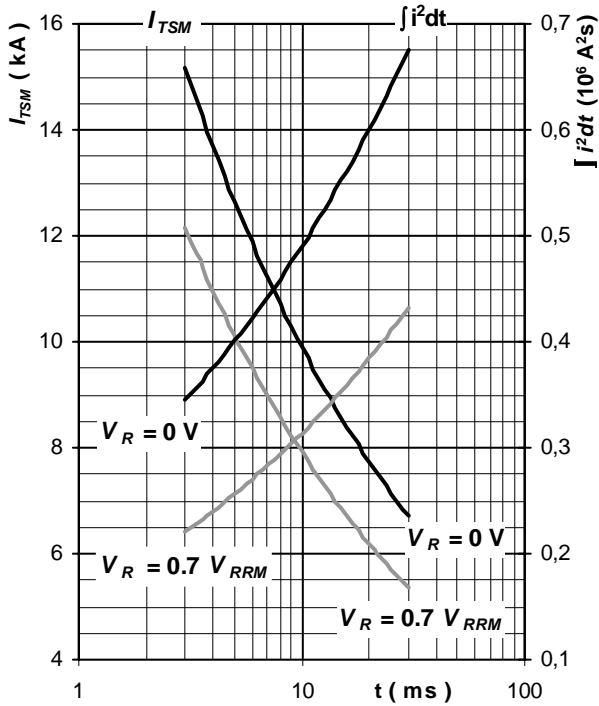

Fig. 4 Surge on-state current vs. pulse length, half sine wave, single pulse, $T_j = T_{jmax}$

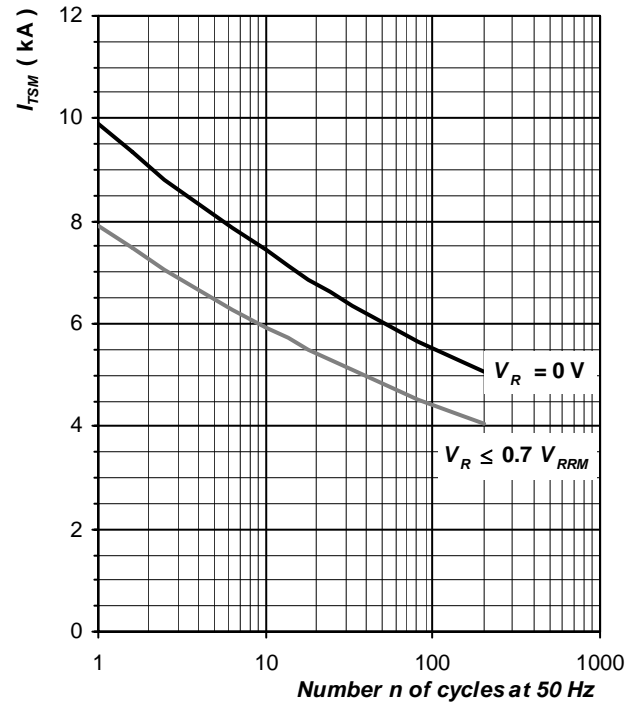

Fig. 5 Surge forward current vs. number of pulses. Half sine wave, $T_j = T_{jmax}$

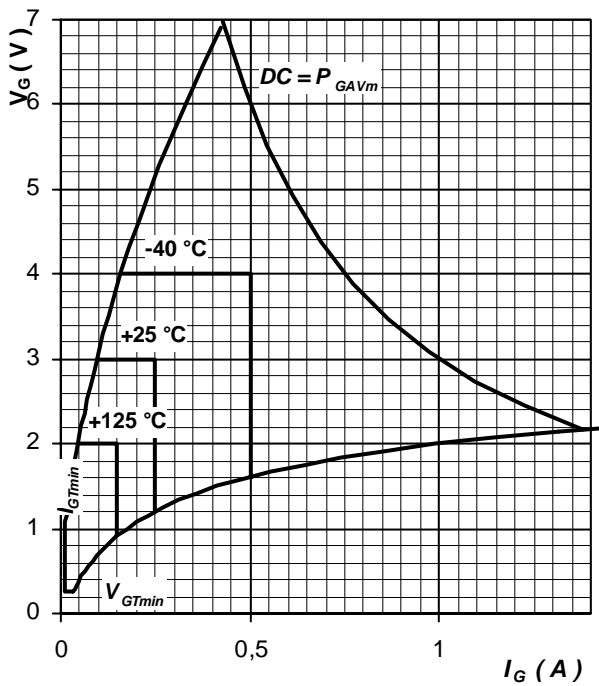

Fig. 6 Gate trigger characteristics – switching

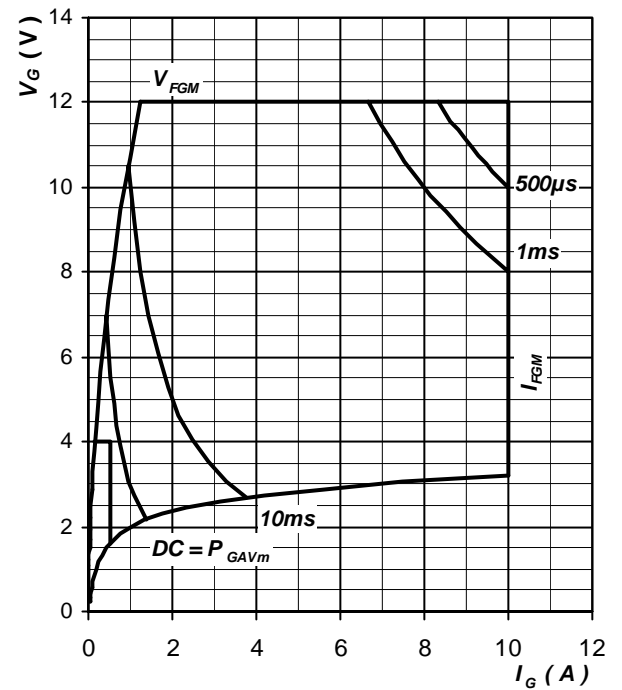

Fig. 7 Gate trigger characteristics – max. peak gate power loss (single pulses)

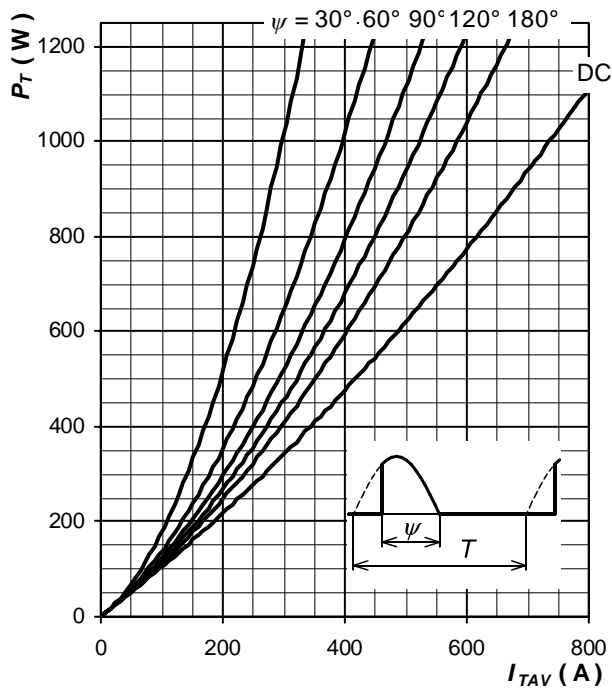

Fig. 8 On-state power loss vs. average on-state current, sine waveform, $f = 50/60$ Hz, $T = 1/f$

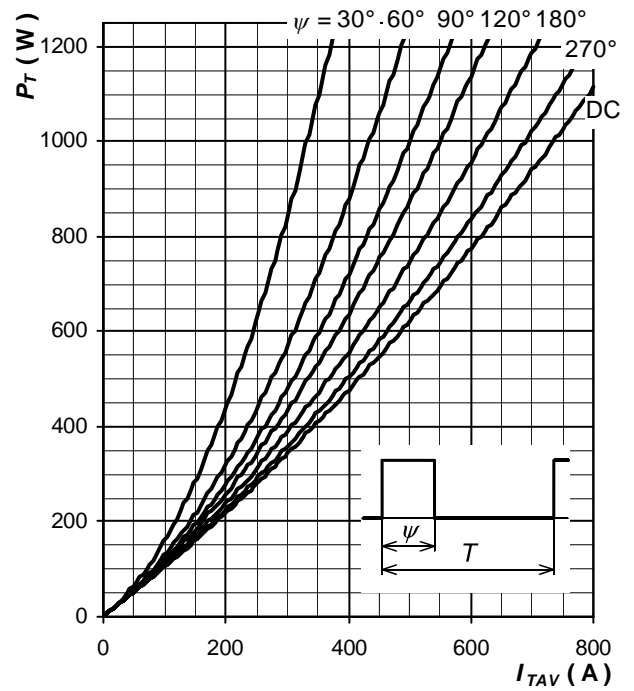

Fig. 9 On-state power loss vs. average on-state current, square waveform, $f = 50/60$ Hz, $T = 1/f$

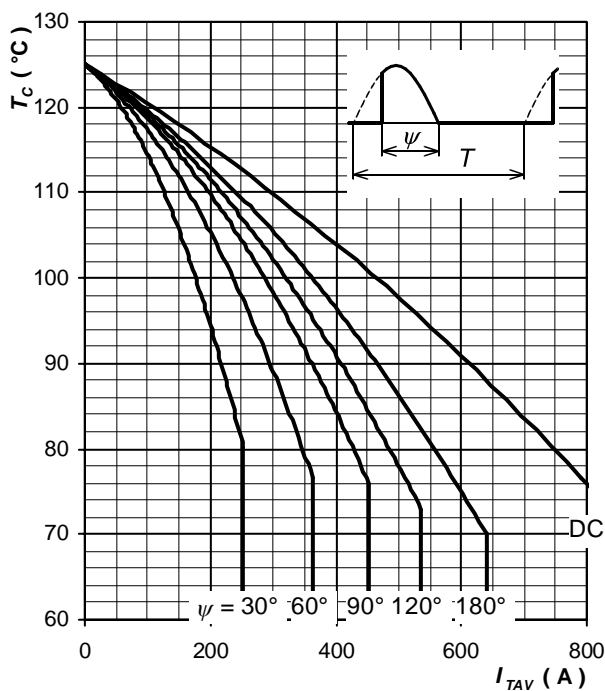

Fig. 10 Max. case temperature vs. aver. on-state current, sine waveform, $f = 50/60$ Hz, $T = 1/f$

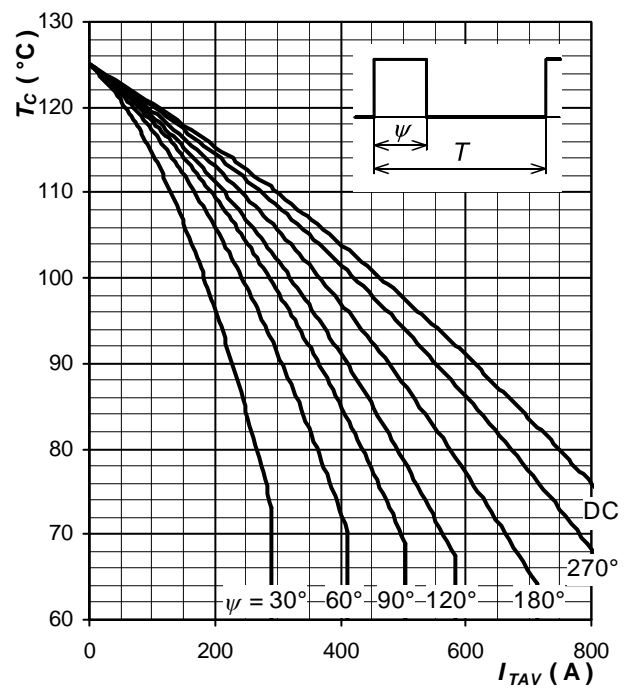

Fig. 11 Max. case temperature vs. aver. on-state current, square waveform, $f = 50/60$ Hz, $T = 1/f$

Notes:

ABB s.r.o., Novodvorska 1768/138a, 142 21 Praha 4, Czech Republic

ABB s.r.o. reserves the right to change the data contained herein at any time without notice