

Major Ratings and Characteristics

Characteristics	83CNQ...	Units
$I_{F(AV)}$ Rectangular waveform	80	A
V_{RRM} range	80 to 100	V
I_{FSM} @ tp = 5 μ s sine	7000	A
V_F @ 40 Apk, $T_J = 125^\circ\text{C}$ (per leg)	0.67	V
T_J range	-55 to 175	$^\circ\text{C}$

Description/Features

The 83CNQ center tap Schottky rectifier module series has been optimized for low reverse leakage at high temperature. The proprietary barrier technology allows for reliable operation up to 175 $^\circ\text{C}$ junction temperature. Typical applications are in switching power supplies, converters, free-wheeling diodes, and reverse battery protection.

- 175 $^\circ\text{C}$ T_J operation
- Center tap module
- High purity, high temperature epoxy encapsulation for enhanced mechanical strength and moisture resistance
- Low forward voltage drop
- High frequency operation
- Guard ring for enhanced ruggedness and long term reliability
- Low profile, small footprint, high current package

Case Styles

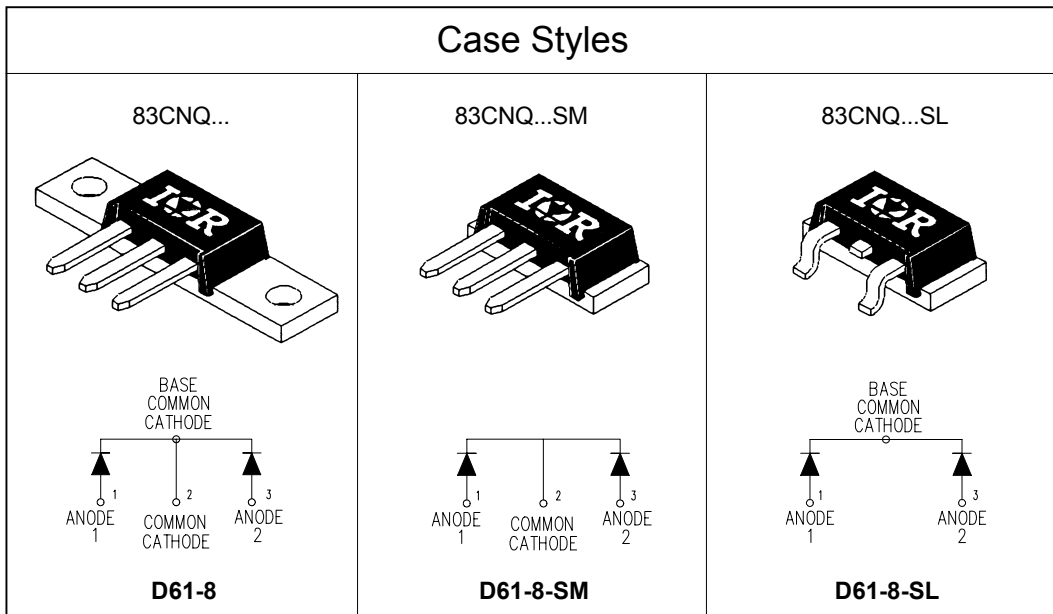

Voltage Ratings

Part number	83CNQ080	83CNQ100
V_R Max. DC Reverse Voltage (V)	80	100
V_{RWM} Max. Working Peak Reverse Voltage (V)		

Absolute Maximum Ratings

Parameters	83CNQ	Units	Conditions
$I_{F(AV)}$ Max. Average Forward Current * See Fig. 5	80	A	50% duty cycle @ $T_C = 132^\circ\text{C}$, rectangular wave form
I_{FSM} Max. Peak One Cycle Non-Repetitive Surge Current (Per Leg) * See Fig. 7	7000	A	5 μs Sine or 3 μs Rect. pulse 10ms Sine or 6ms Rect. pulse
	720		
E_{AS} Non-Repetitive Avalanche Energy (Per Leg)	15	mJ	$T_J = 25^\circ\text{C}$, $I_{AS} = 1$ Amps, $L = 30$ mH
I_{AR} Repetitive Avalanche Current (Per Leg)	1	A	Current decaying linearly to zero in 1 μsec Frequency limited by $T_{J,max}$. $V_A = 1.5 \times V_R$ typical

Electrical Specifications

Parameters	83CNQ	Units	Conditions
V_{FM} Max. Forward Voltage Drop (Per Leg) * See Fig. 1 (1)	0.81	V	@ 40A $T_J = 25^\circ\text{C}$
	1.00	V	@ 80A
	0.67	V	@ 40A $T_J = 125^\circ\text{C}$
	0.82	V	@ 80A
I_{RM} Max. Reverse Leakage Current (Per Leg) * See Fig. 2 (1)	1.5	mA	$T_J = 25^\circ\text{C}$ $V_R = \text{rated } V_R$
	35	mA	$T_J = 125^\circ\text{C}$
C_T Max. Junction Capacitance (Per Leg)	1400	pF	$V_R = 5V_{DC}$, (test signal range 100Khz to 1Mhz) 25°C
L_S Typical Series Inductance (Per Leg)	5.5	nH	Measured lead to lead 5mm from package body
dv/dt Max. Voltage Rate of Change (Rated V_R)	10,000	V/ μs	

(1) Pulse Width < 300 μs , Duty Cycle < 2%

Thermal-Mechanical Specifications

Parameters	83CNQ	Units	Conditions
T_J Max. Junction Temperature Range	-55 to 175	$^\circ\text{C}$	
T_{stg} Max. Storage Temperature Range	-55 to 175	$^\circ\text{C}$	
R_{thJC} Max. Thermal Resistance Junction to Case (Per Leg)	0.85	$^\circ\text{C/W}$	DC operation * See Fig. 4
R_{thJC} Max. Thermal Resistance Junction to Case (Per Package)	0.42	$^\circ\text{C/W}$	DC operation
R_{thCS} Typical Thermal Resistance, Case to Heatsink (D61-8 Only)	0.30	$^\circ\text{C/W}$	Mounting surface, smooth and greased Device flatness < 5mils
wt Approximate Weight	7.8(0.28)	g(oz.)	
T Mounting Torque	Min. 12(10) Max. 24(20)	Kg-cm (lbf-in)	(*)

(*) Recommended hardware 3M stainless screw

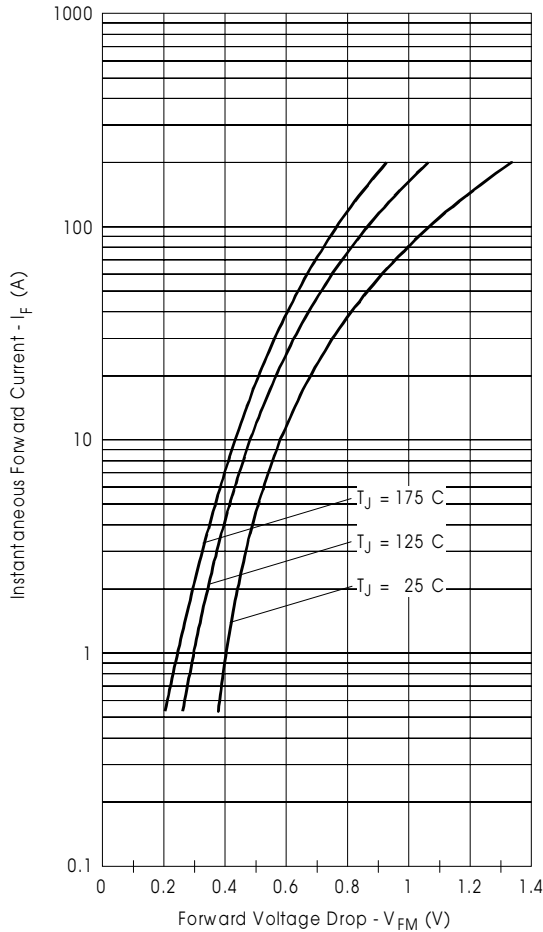

Fig. 1 - Max. Forward Voltage Drop Characteristics (PerLeg)

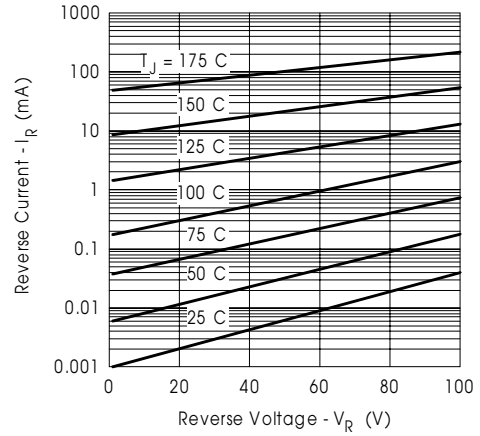

Fig. 2 - Typical Values Of Reverse Current Vs. Reverse Voltage (PerLeg)

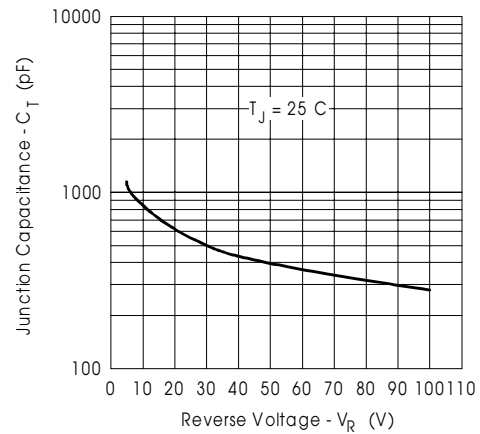

Fig. 3 - Typical Junction Capacitance Vs. Reverse Voltage (PerLeg)

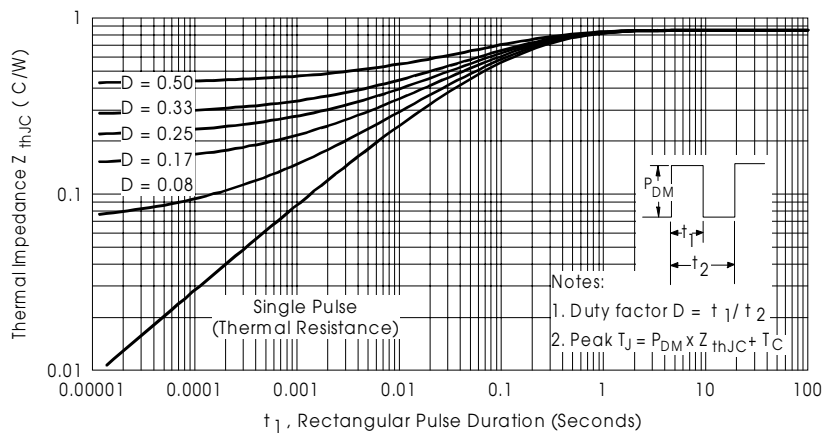

Fig. 4 - Max. Thermal Impedance Z_{thJC} Characteristics (PerLeg)

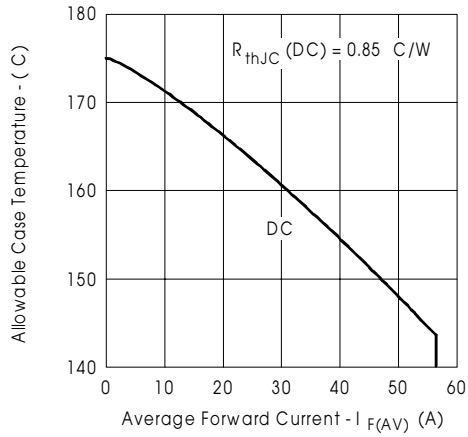

Fig. 5- Max. Allowable Case Temperature Vs. Average Forward Current (Per Leg)

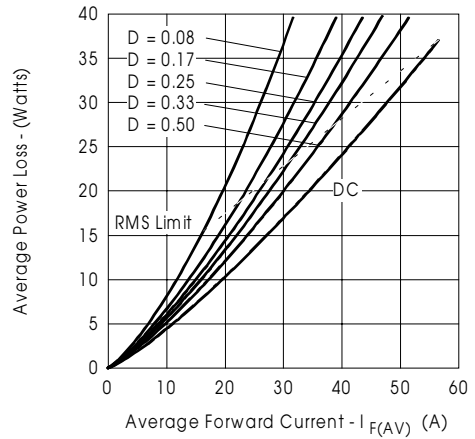

Fig. 6- Forward Power Loss Characteristics (Per Leg)

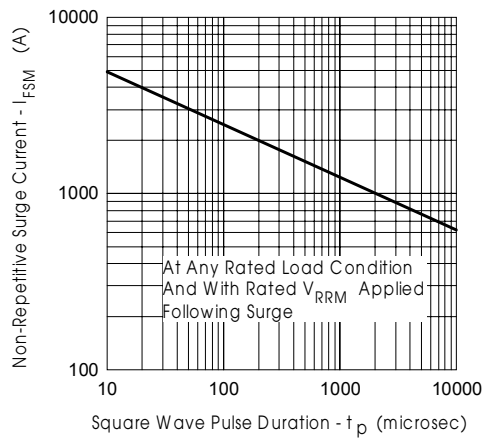

Fig. 7- Max. Non-Repetitive Surge Current (Per Leg)

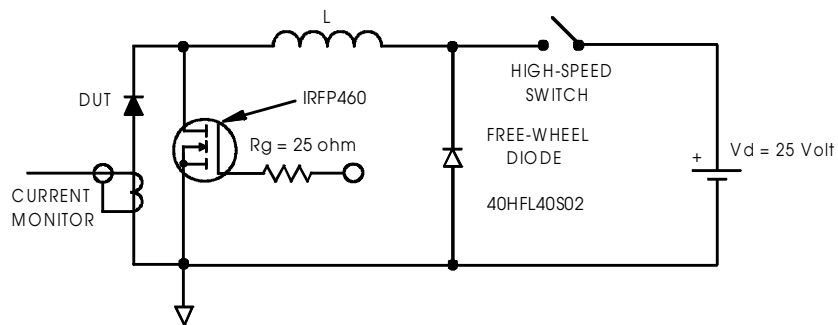
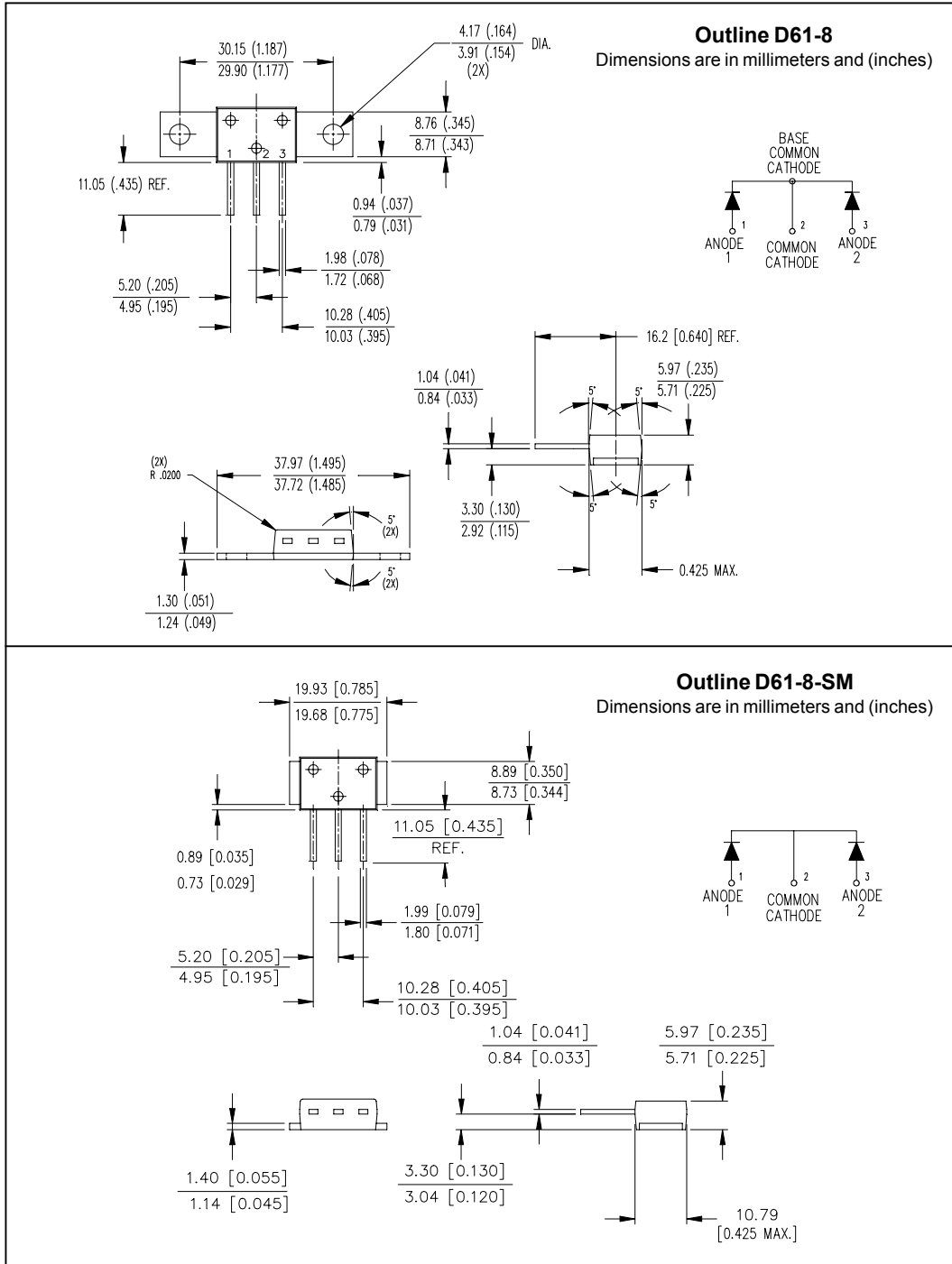
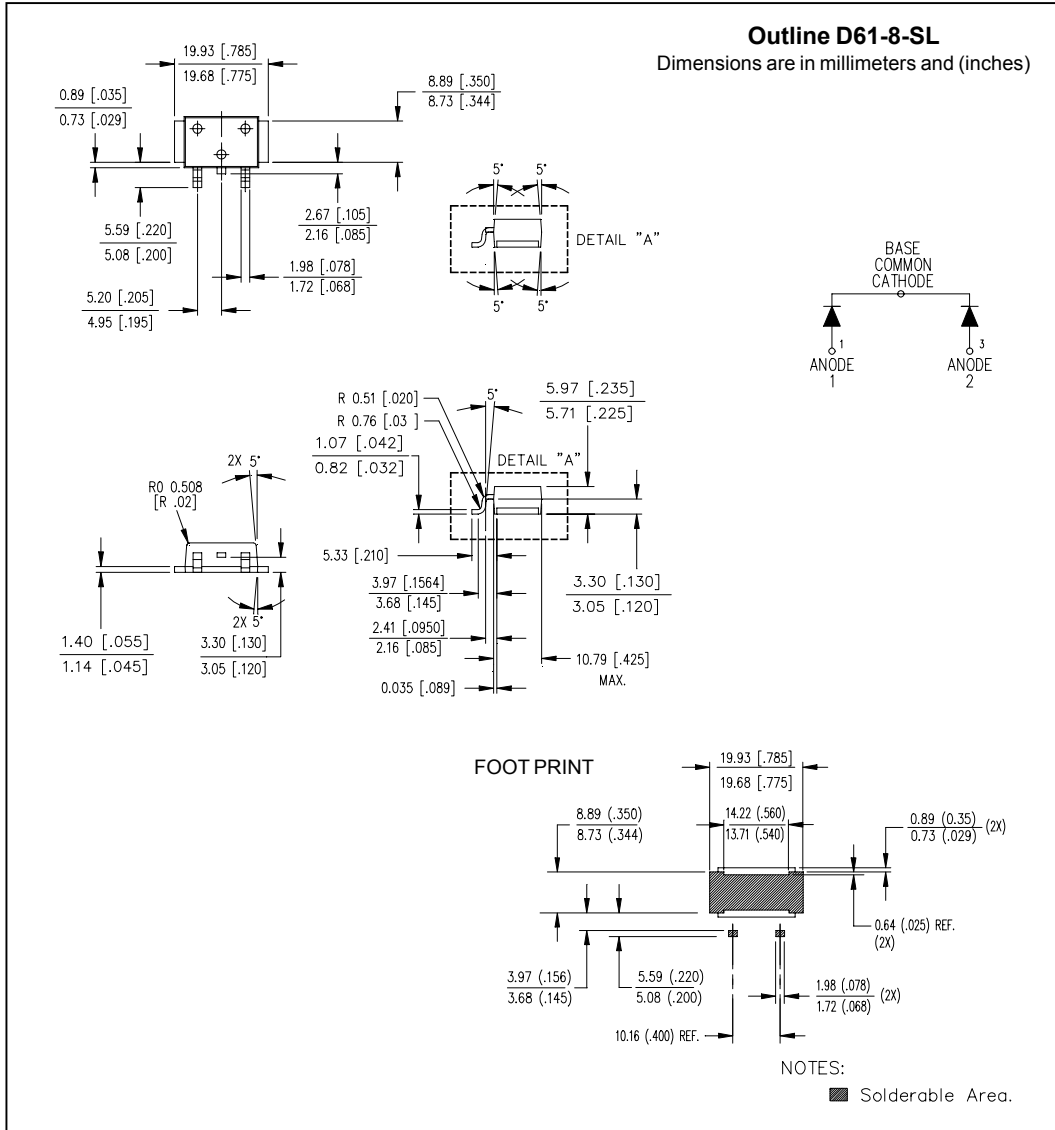

Fig. 8- Unclamped Inductive Test Circuit

Outline Table



Outline Table



Part Marking Information

EXAMPLE: THIS IS A 83CNQ030 WITH
 LOT CODE 89 09
 ASSEMBLED ON WW 45, 2000
 IN THE ASSEMBLY LINE "A"

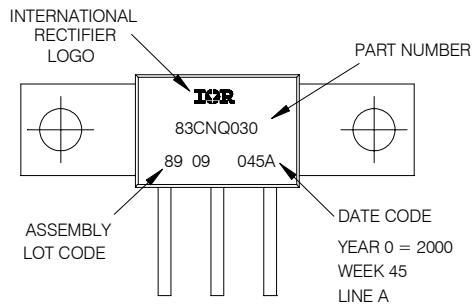

D61-8

EXAMPLE: THIS IS A 83CNQ030SM WITH
 LOT CODE 89 09
 ASSEMBLED ON WW 45, 2000
 IN THE ASSEMBLY LINE "A"

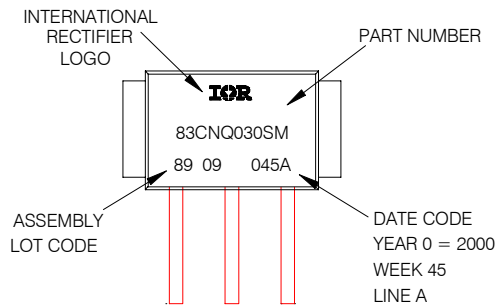

D61-8-SM

EXAMPLE: THIS IS A 83CNQ030SL WITH
 LOT CODE 89 09
 ASSEMBLED ON WW 45, 2000
 IN THE ASSEMBLY LINE "A"

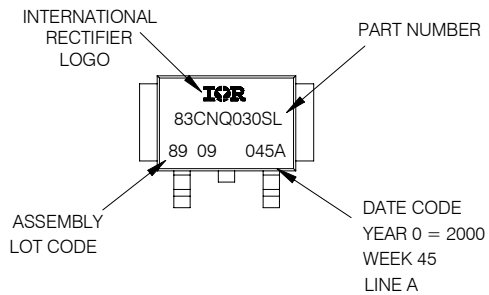

D61-8-SL

```

83CNQ100
*****
* This model has been developed by *
* Wizard SPICE MODEL GENERATOR (1999) *
* (International Rectifier Corporation) *
* contains Proprietary Information *
*****
* SPICE Model Diode is composed by a *
* simple diode plus paralalled VCG2T *
*****
.SUBCKT 83CNQ100 ANO CAT
D1 ANO 1 DMOD (0.20831)
*Define diode model
.MODEL DMODD (IS=3.91765102575707E-04A,N=1.6412007115037,BV=110V,
+IBV=1.66611874283115A,RS=0.001083212,CJO=1.31909764291715E-08,
+VJ=1.04145964983498,XTI=2,EG=0.757359996913038)
*****
*Implementation of VCG2T
VX 1 2 DC 0V
R1 2 CAT TRES 1E-6
.MODEL TRES RES (R=1,TC1=-5.06642501757023)
GP1 ANO CAT VALUE={-ABS(I(VX))*(EXP((((2.558893E-02/-5.066425)*(V(2,CAT)*1E6)/(I(VX)+1E-6)-1))+1)*3.120336E-
03*ABS(V(ANO,CAT)))-1}}
*****
.ENDS 83CNQ100

Thermal Model Subcircuit
.SUBCKT 83CNQ100 5 1

CTHERM1 5 4 8.75E-04
CTHERM2 4 3 1.99E+00
CTHERM3 3 2 2.04E+01
CTHERM4 2 1 2.41E+02

RTHERM1 5 4 1.00E-07
RTHERM2 4 3 4.51E-01
RTHERM1 3 2 3.08E-01
RTHERM1 2 1 7.27E-02

.ENDS 83CNQ100

```

Data and specifications subject to change without notice.
This product has been designed and qualified for Industrial Level.
Qualification Standards can be found on IR's Web site.

International
IR Rectifier

IR WORLD HEADQUARTERS: 233 Kansas St., El Segundo, California 90245, USA Tel: (310) 252-7105
TAC Fax: (310) 252-7309
Visit us at www.irf.com for sales contact information. 09/01

This datasheet has been download from:

www.datasheetcatalog.com

Datasheets for electronics components.