

ADR01/ADR02/ADR03/ADR06

FEATURES

- Ultracompact SC70 and TSOT packages**
- Low temperature coefficient**
 - 8-lead SOIC: 3 ppm/°C
 - 5-lead SC70, 5-lead TSOT: 9 ppm/°C
- Initial accuracy ±0.1%**
- No external capacitor required**
- Low noise 10 μV p-p (0.1 Hz to 10.0 Hz)**
- Wide operating range**
 - ADR01: 12.0 V to 40.0 V
 - ADR02: 7.0 V to 40.0 V
 - ADR03: 4.5 V to 40.0 V
 - ADR06: 5.0 V to 40.0 V
- High output current 10 mA**
- Wide temperature range: -40°C to +125°C**
- ADR01/ADR02/ADR03 pin compatible to industry-standard REF01/REF02/REF03¹**

APPLICATIONS

- Precision data acquisition systems**
- High resolution converters**
- Industrial process control systems**
- Precision instruments**
- PCMCIA cards**

GENERAL DESCRIPTION

The ADR01, ADR02, ADR03, and ADR06 are precision 10.0 V, 5.0 V, 2.5 V, and 3.0 V band gap voltage references featuring high accuracy, high stability, and low power. The parts are housed in tiny, 5-lead SC70 and TSOT packages, as well as in 8-lead SOIC versions. The SOIC versions of the ADR01, ADR02, and ADR03 are drop-in replacements¹ to the industry-standard REF01, REF02, and REF03. The small footprint and wide operating range make the ADR0x references ideally suited for general-purpose and space-constrained applications.

With an external buffer and a simple resistor network, the TEMP terminal can be used for temperature sensing and approximation. A TRIM terminal is provided on the devices for fine adjustment of the output voltage.

PIN CONFIGURATIONS

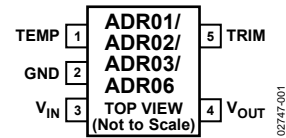
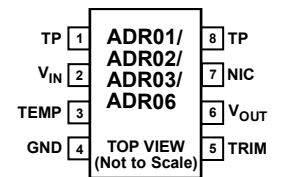

Figure 1. 5-Lead, SC70/TSOT Surface-Mount Packages



NIC = NO INTERNAL CONNECT
TP = TEST PIN (DO NOT CONNECT)

Figure 2. 8-Lead, SOIC Surface-Mount Package

The ADR01, ADR02, ADR03, and ADR06 are compact, low drift voltage references that provide an extremely stable output voltage from a wide supply voltage range. They are available in 5-lead SC70 and TSOT packages, and 8-lead SOIC packages with A, B, and C grade selections. All parts are specified over the extended industrial (-40°C to +125°C) temperature range.

Table 1. Selection Guide

Part Number	Output Voltage
ADR01	10.0 V
ADR02	5.0 V
ADR03	2.5 V
ADR06	3.0 V

¹ ADR01, ADR02, and ADR03 are component-level compatible with REF01, REF02, and REF03, respectively. No guarantees for system-level compatibility are implied. SOIC versions of ADR01/ADR02/ADR03 are pin-to-pin compatible with 8-lead SOIC versions of REF01/REF02/REF03, respectively, with the additional temperature monitoring function.

Rev. K

Information furnished by Analog Devices is believed to be accurate and reliable. However, no responsibility is assumed by Analog Devices for its use, nor for any infringements of patents or other rights of third parties that may result from its use. Specifications subject to change without notice. No license is granted by implication or otherwise under any patent or patent rights of Analog Devices. Trademarks and registered trademarks are the property of their respective owners.

TABLE OF CONTENTS

Features	1	ESD Caution.....	8
Applications.....	1	Terminology.....	9
Pin Configurations	1	Typical Performance Characteristics	10
General Description	1	Applications.....	15
Revision History	2	Applying the ADR01/ADR02/ADR03/ADR06.....	15
Specifications.....	3	Negative Reference.....	16
ADR01 Electrical Characteristics.....	3	Low Cost Current Source.....	16
ADR02 Electrical Characteristics.....	4	Precision Current Source with Adjustable Output	16
ADR03 Electrical Characteristics.....	5	Programmable 4 mA to 20 mA Current Transmitter.....	17
ADR06 Electrical Characteristics.....	6	Precision Boosted Output Regulator	17
Die Electrical Characteristics.....	7	Outline Dimensions	18
Absolute Maximum Ratings.....	8	Ordering Guides.....	19
Thermal Resistance	8		

REVISION HISTORY

2/08—Rev. J to Rev. K

Changes to Terminology Section.....	9
Changes to Ordering Guide	19

3/07—Rev. I to Rev. J

Renamed Parameters and Definitions Section.....	9
Changes to Temperature Monitoring Section	15
Changes to Ordering Guide	19

7/05—Rev. H to Rev. I

Changes to Table 5.....	7
Updated Outline Dimensions	19
Changes to Ordering Guide	19

12/04—Rev. G to Rev. H

Changes to ADR06 Ordering Guide	20
---------------------------------------	----

9/04—Rev. F to Rev. G

Changes to Table 2.....	4
Changes to Table 3.....	5
Changes to Table 4.....	6
Changes to Table 5.....	7
Changes to Ordering Guide	19

7/04—Rev. E to Rev. F

Changes to ADR02 Electrical Characteristics, Table 2.....	4
Changes to Ordering Guide	19

2/04—Rev. D to Rev. E

Added C grade	Universal
Changes to Outline Dimensions.....	19
Updated Ordering Guide.....	20

8/03—Rev. C to Rev. D

Added ADR06.....	Universal
Change to Figure 27	13

6/03—Rev. B to Rev. C

Changes to Features Section	1
Changes to General Description Section	1
Changes to Figure 2.....	1
Changes to Specifications Section.....	2
Addition of Dice Electrical Characteristics and Layout.....	6
Changes to Absolute Maximum Ratings Section.....	7
Updated SOIC (R-8) Outline Dimensions	19
Changes to Ordering Guide	20

2/03—Rev. A to Rev. B

Added ADR03.....	Universal
Added TSOT-5 (UJ) Package	Universal
Updated Outline Dimensions	18

12/02—Rev. 0 to Rev. A

Changes to Features Section	1
Changes to General Description	1
Table I deleted	1
Changes to ADR01 Specifications.....	2
Changes to ADR02 Specifications.....	3
Changes to Absolute Maximum Ratings Section.....	4
Changes to Ordering Guide	4
Updated Outline Dimensions	12

SPECIFICATIONS

ADR01 ELECTRICAL CHARACTERISTICS

$V_{IN} = 12.0\text{ V to }40.0\text{ V}$, $T_A = 25^\circ\text{C}$, unless otherwise noted.

Table 2.

Parameter	Symbol	Conditions	Min	Typ	Max	Unit
OUTPUT VOLTAGE	V_O	A and C grades	9.990	10.000	10.010	V
INITIAL ACCURACY	V_{OERR}	A and C grades			10 0.1	mV %
OUTPUT VOLTAGE	V_O	B grade	9.995	10.000	10.005	V
INITIAL ACCURACY	V_{OERR}	B grade			5 0.05	mV %
TEMPERATURE COEFFICIENT	TCV_O	A grade, 8-lead SOIC, $-40^\circ\text{C} < T_A < +125^\circ\text{C}$ A grade, 5-lead TSOT, $-40^\circ\text{C} < T_A < +125^\circ\text{C}$ A grade, 5-lead SC70, $-40^\circ\text{C} < T_A < +125^\circ\text{C}$ B grade, 8-lead SOIC, $-40^\circ\text{C} < T_A < +125^\circ\text{C}$ B grade, 5-lead TSOT, $-40^\circ\text{C} < T_A < +125^\circ\text{C}$ B grade, 5-lead SC70, $-40^\circ\text{C} < T_A < +125^\circ\text{C}$ C grade, 8-lead SOIC, $-40^\circ\text{C} < T_A < +125^\circ\text{C}$		3 1 10	10 25 25 3 9 9 40	ppm/ $^\circ\text{C}$ ppm/ $^\circ\text{C}$ ppm/ $^\circ\text{C}$ ppm/ $^\circ\text{C}$ ppm/ $^\circ\text{C}$ ppm/ $^\circ\text{C}$ ppm/ $^\circ\text{C}$
SUPPLY VOLTAGE HEADROOM	$V_{IN} - V_O$		2			V
LINE REGULATION	$\Delta V_O / \Delta V_{IN}$	$V_{IN} = 12.0\text{ V to }40.0\text{ V}$, $-40^\circ\text{C} < T_A < +125^\circ\text{C}$		7	30	ppm/V
LOAD REGULATION	$\Delta V_O / \Delta I_{LOAD}$	$I_{LOAD} = 0\text{ mA to }10\text{ mA}$, $-40^\circ\text{C} < T_A < +125^\circ\text{C}$, $V_{IN} = 15.0\text{ V}$		40	70	ppm/mA
QUIESCENT CURRENT	I_{IN}	No load, $-40^\circ\text{C} < T_A < +125^\circ\text{C}$		0.65	1	mA
VOLTAGE NOISE	$e_{N\text{ p-p}}$	0.1 Hz to 10.0 Hz		20		$\mu\text{V p-p}$
VOLTAGE NOISE DENSITY	e_N	1 kHz		510		nV/ $\sqrt{\text{Hz}}$
TURN-ON SETTLING TIME	t_R			4		μs
LONG-TERM STABILITY ¹	ΔV_O	1000 hours		50		ppm
OUTPUT VOLTAGE HYSTERESIS	ΔV_{O_HYS}			70		ppm
RIPPLE REJECTION RATIO	RRR	$f_{IN} = 10\text{ kHz}$		-75		dB
SHORT CIRCUIT TO GND	I_{SC}			30		mA
VOLTAGE OUTPUT AT TEMP PIN	V_{TEMP}			550		mV
TEMPERATURE SENSITIVITY	TCV_{TEMP}			1.96		mV/ $^\circ\text{C}$

¹ The long-term stability specification is noncumulative. The drift in subsequent 1000 hour periods is significantly lower than in the first 1000 hour period.

ADRO1/ADRO2/ADRO3/ADRO6

ADRO2 ELECTRICAL CHARACTERISTICS

$V_{IN} = 7.0\text{ V to }40.0\text{ V}$, $T_A = 25^\circ\text{C}$, unless otherwise noted.

Table 3.

Parameter	Symbol	Conditions	Min	Typ	Max	Unit
OUTPUT VOLTAGE	V_O	A and C grades	4.995	5.000	5.005	V
INITIAL ACCURACY	V_{OERR}	A and C grades			5 0.1	mV %
OUTPUT VOLTAGE	V_O	B grade	4.997	5.000	5.003	V
INITIAL ACCURACY	V_{OERR}	B grade			3 0.06	mV %
TEMPERATURE COEFFICIENT	T_{CVO}	A grade, 8-lead SOIC, $-40^\circ\text{C} < T_A < +125^\circ\text{C}$ A grade, 5-lead TSOT, $-40^\circ\text{C} < T_A < +125^\circ\text{C}$ A grade, 5-lead SC70, $-40^\circ\text{C} < T_A < +125^\circ\text{C}$ A grade, 5-lead SC70, $-55^\circ\text{C} < T_A < +125^\circ\text{C}$ B grade, 8-lead SOIC, $-40^\circ\text{C} < T_A < +125^\circ\text{C}$ B grade, 5-lead TSOT, $-40^\circ\text{C} < T_A < +125^\circ\text{C}$ B grade, 5-lead SC70, $-40^\circ\text{C} < T_A < +125^\circ\text{C}$ C grade, 8-lead SOIC, $-40^\circ\text{C} < T_A < +125^\circ\text{C}$		3 1 10	10 25 25 30 3 9 9 40	ppm/ $^\circ\text{C}$ ppm/ $^\circ\text{C}$ ppm/ $^\circ\text{C}$ ppm/ $^\circ\text{C}$ ppm/ $^\circ\text{C}$ ppm/ $^\circ\text{C}$ ppm/ $^\circ\text{C}$ ppm/ $^\circ\text{C}$
SUPPLY VOLTAGE HEADROOM	$V_{IN} - V_O$		2			V
LINE REGULATION	$\Delta V_O / \Delta V_{IN}$	$V_{IN} = 7.0\text{ V to }40.0\text{ V}$, $-40^\circ\text{C} < T_A < +125^\circ\text{C}$ $V_{IN} = 7.0\text{ V to }40.0\text{ V}$, $-55^\circ\text{C} < T_A < +125^\circ\text{C}$		7 7	30 40	ppm/V ppm/V
LOAD REGULATION	$\Delta V_O / \Delta I_{LOAD}$	$I_{LOAD} = 0\text{ mA to }10\text{ mA}$, $-40^\circ\text{C} < T_A < +125^\circ\text{C}$, $V_{IN} = 10.0\text{ V}$ $I_{LOAD} = 0\text{ mA to }10\text{ mA}$, $-55^\circ\text{C} < T_A < +125^\circ\text{C}$, $V_{IN} = 10.0\text{ V}$		40 45	70 80	ppm/mA ppm/mA
QUIESCENT CURRENT	I_{IN}	No load, $-40^\circ\text{C} < T_A < +125^\circ\text{C}$		0.65	1	mA
VOLTAGE NOISE	$e_{N\text{ p-p}}$	0.1 Hz to 10.0 Hz		10		$\mu\text{V p-p}$
VOLTAGE NOISE DENSITY	e_N	1 kHz		230		nV/ $\sqrt{\text{Hz}}$
TURN-ON SETTLING TIME	t_R			4		μs
LONG-TERM STABILITY ¹	ΔV_O	1000 hours		50		ppm
OUTPUT VOLTAGE HYSTERESIS	ΔV_{O_HYS}	$-55^\circ\text{C} < T_A < +125^\circ\text{C}$		70 80		ppm ppm
RIPPLE REJECTION RATIO	RRR	$f_{IN} = 10\text{ kHz}$		-75		dB
SHORT CIRCUIT TO GND	I_{SC}			30		mA
VOLTAGE OUTPUT AT TEMP PIN	V_{TEMP}			550		mV
TEMPERATURE SENSITIVITY	TCV_{TEMP}			1.96		mV/ $^\circ\text{C}$

¹ The long-term stability specification is noncumulative. The drift in subsequent 1000 hour periods is significantly lower than in the first 1000 hour period.

ADR03 ELECTRICAL CHARACTERISTICS

$V_{IN} = 4.5\text{ V to }40.0\text{ V}$, $T_A = 25^\circ\text{C}$, unless otherwise noted.

Table 4.

Parameter	Symbol	Conditions	Min	Typ	Max	Unit
OUTPUT VOLTAGE	V_O	A and C grades	2.495	2.500	2.505	V
INITIAL ACCURACY	V_{OERR}	A and C grades			5	mV
					0.2	%
OUTPUT VOLTAGE	V_O	B grades	2.4975	2.5000	2.5025	V
INITIAL ACCURACY	V_{OERR}	B grades			2.5	mV
					0.1	%
TEMPERATURE COEFFICIENT	TCV_O	A grade, 8-lead SOIC, $-40^\circ\text{C} < T_A < +125^\circ\text{C}$ A grade, 5-lead TSOT, $-40^\circ\text{C} < T_A < +125^\circ\text{C}$ A grade, 5-lead SC70, $-40^\circ\text{C} < T_A < +125^\circ\text{C}$ A grade, 5-lead SC70, $-55^\circ\text{C} < T_A < +125^\circ\text{C}$ B grade, 8-lead SOIC, $-40^\circ\text{C} < T_A < +125^\circ\text{C}$ B grade, 5-lead TSOT, $-40^\circ\text{C} < T_A < +125^\circ\text{C}$ B grade, 5-lead SC70, $-40^\circ\text{C} < T_A < +125^\circ\text{C}$ C grade, 8-lead SOIC, $-40^\circ\text{C} < T_A < +125^\circ\text{C}$		3	10	ppm/ $^\circ\text{C}$
					25	ppm/ $^\circ\text{C}$
					25	ppm/ $^\circ\text{C}$
					30	ppm/ $^\circ\text{C}$
			1		3	ppm/ $^\circ\text{C}$
					9	ppm/ $^\circ\text{C}$
					9	ppm/ $^\circ\text{C}$
			10		40	ppm/ $^\circ\text{C}$
SUPPLY VOLTAGE HEADROOM	$V_{IN} - V_O$		2			V
LINE REGULATION	$\Delta V_O / \Delta V_{IN}$	$V_{IN} = 4.5\text{ V to }40.0\text{ V}$, $-40^\circ\text{C} < T_A < +125^\circ\text{C}$ $V_{IN} = 4.5\text{ V to }40.0\text{ V}$, $-55^\circ\text{C} < T_A < +125^\circ\text{C}$		7	30	ppm/V
				7	40	ppm/V
LOAD REGULATION	$\Delta V_O / \Delta I_{LOAD}$	$I_{LOAD} = 0\text{ mA to }10\text{ mA}$, $-40^\circ\text{C} < T_A < +125^\circ\text{C}$, $V_{IN} = 7.0\text{ V}$ $I_{LOAD} = 0\text{ mA to }10\text{ mA}$, $-55^\circ\text{C} < T_A < +125^\circ\text{C}$, $V_{IN} = 7.0\text{ V}$		25	70	ppm/mA
				45	80	ppm/mA
QUIESCENT CURRENT	I_{IN}	No load, $-40^\circ\text{C} < T_A < +125^\circ\text{C}$		0.65	1	mA
VOLTAGE NOISE	$e_{N\text{ p-p}}$	0.1 Hz to 10.0 Hz		6		$\mu\text{V p-p}$
VOLTAGE NOISE DENSITY	e_N	1 kHz		230		nV/ $\sqrt{\text{Hz}}$
TURN-ON SETTLING TIME	t_R			4		μs
LONG-TERM STABILITY ¹	ΔV_O	1000 hours		50		ppm
OUTPUT VOLTAGE HYSTERESIS	ΔV_{O_HYS}	$-55^\circ\text{C} < T_A < +125^\circ\text{C}$		70		ppm
				80		ppm
RIPPLE REJECTION RATIO	RRR	$f_{IN} = 10\text{ kHz}$		-75		dB
SHORT CIRCUIT TO GND	I_{SC}			30		mA
VOLTAGE OUTPUT AT TEMP PIN	V_{TEMP}			550		mV
TEMPERATURE SENSITIVITY	TCV_{TEMP}			1.96		mV/ $^\circ\text{C}$

¹ The long-term stability specification is noncumulative. The drift in subsequent 1000 hour periods is significantly lower than in the first 1000 hour period.

ADRO1/ADRO2/ADRO3/ADRO6

ADRO6 ELECTRICAL CHARACTERISTICS

$V_{IN} = 5.0\text{ V to }40.0\text{ V}$, $T_A = 25^\circ\text{C}$, unless otherwise noted.

Table 5.

Parameter	Symbol	Conditions	Min	Typ	Max	Unit
OUTPUT VOLTAGE	V_O	A and C grades	2.994	3.000	3.006	V
INITIAL ACCURACY	V_{OERR}	A and C grades			6 0.2	mV %
OUTPUT VOLTAGE	V_O	B grade	2.997	3.000	3.003	V
INITIAL ACCURACY	V_{OERR}	B grade			3 0.1	mV %
TEMPERATURE COEFFICIENT	TCV_O	A grade, 8-lead SOIC, $-40^\circ\text{C} < T_A < +125^\circ\text{C}$ A grade, 5-lead TSOT, $-40^\circ\text{C} < T_A < +125^\circ\text{C}$ A grade, 5-lead SC70, $-40^\circ\text{C} < T_A < +125^\circ\text{C}$ B grade, 8-lead SOIC, $-40^\circ\text{C} < T_A < +125^\circ\text{C}$ B grade, 5-lead TSOT, $-40^\circ\text{C} < T_A < +125^\circ\text{C}$ B grade, 5-lead SC70, $-40^\circ\text{C} < T_A < +125^\circ\text{C}$ C grade, 8-lead SOIC, $-40^\circ\text{C} < T_A < +125^\circ\text{C}$		3 1 10	10 25 25 3 9 9 40	ppm/ $^\circ\text{C}$ ppm/ $^\circ\text{C}$ ppm/ $^\circ\text{C}$ ppm/ $^\circ\text{C}$ ppm/ $^\circ\text{C}$ ppm/ $^\circ\text{C}$ ppm/ $^\circ\text{C}$
SUPPLY VOLTAGE HEADROOM	$V_{IN} - V_O$		2			V
LINE REGULATION	$\Delta V_O / \Delta V_{IN}$	$V_{IN} = 5.0\text{ V to }40.0\text{ V}$, $-40^\circ\text{C} < T_A < +125^\circ\text{C}$		7	30	ppm/V
LOAD REGULATION	$\Delta V_O / \Delta I_{LOAD}$	$I_{LOAD} = 0\text{ mA to }10\text{ mA}$, $-40^\circ\text{C} < T_A < +125^\circ\text{C}$, $V_{IN} = 7.0\text{ V}$		40	70	ppm/mA
QUIESCENT CURRENT	I_{IN}	No load, $-40^\circ\text{C} < T_A < +125^\circ\text{C}$		0.65	1	mA
VOLTAGE NOISE	$e_{N\text{ p-p}}$	0.1 Hz to 10.0 Hz		10		$\mu\text{V p-p}$
VOLTAGE NOISE DENSITY	e_N	1 kHz		510		nV/ $\sqrt{\text{Hz}}$
TURN-ON SETTLING TIME	t_R			4		μs
LONG-TERM STABILITY ¹	ΔV_O	1000 hours		50		ppm
OUTPUT VOLTAGE HYSTERESIS	ΔV_{O_HYS}			70		ppm
RIPPLE REJECTION RATIO	RRR	$f_{IN} = 10\text{ kHz}$		-75		dB
SHORT CIRCUIT TO GND	I_{SC}			30		mA
VOLTAGE OUTPUT AT TEMP PIN	V_{TEMP}			550		mV
TEMPERATURE SENSITIVITY	TCV_{TEMP}			1.96		mV/ $^\circ\text{C}$

¹ The long-term stability specification is noncumulative. The drift in subsequent 1000 hour periods is significantly lower than in the first 1000 hour period.

DIE ELECTRICAL CHARACTERISTICS

V_{IN} = up to 40.0 V, T_A = 25°C, unless otherwise noted.

Table 6.

Parameter	Symbol	Conditions	Min	Typ	Max	Unit
OUTPUT VOLTAGE						
ADR01NBC	V_O	25°C	9.995	10.004	10.005	V
ADR03BNC	V_O	25°C	2.4975	2.501	2.5025	V
TEMPERATURE COEFFICIENT	TCV_O	$-40^\circ\text{C} < T_A < +125^\circ\text{C}$		10		ppm/°C
LINE REGULATION						
ADR01NBC	$\Delta V_O / \Delta V_{IN}$	$V_{IN} = 15.0\text{ V to }40.0\text{ V}$		7		ppm/V
ADR03BNC	$\Delta V_O / \Delta V_{IN}$	$V_{IN} = 4.5\text{ V to }40.0\text{ V}$		7		ppm/V
LOAD REGULATION	$\Delta V_O / \Delta I_{LOAD}$	$I_{LOAD} = 0\text{ to }10\text{ mA}$		40		ppm/mA
QUIESCENT CURRENT	I_{IN}	No load		0.65		mA
VOLTAGE NOISE	$e_{N\text{ p-p}}$	0.1 Hz to 10.0 Hz		25		$\mu\text{V p-p}$

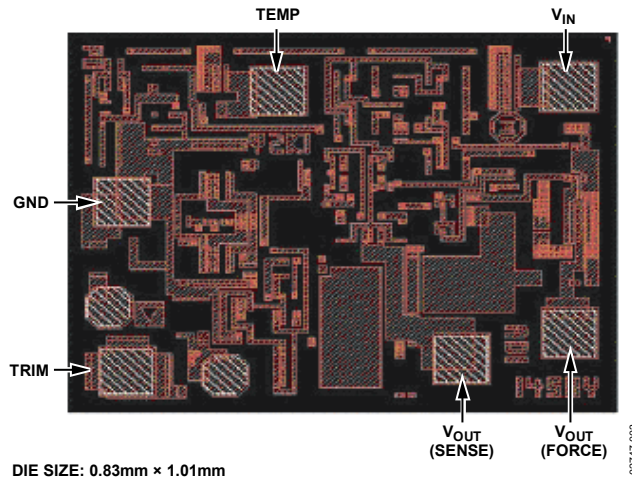

Figure 3. Die Layout

ADRO1/ADRO2/ADRO3/ADRO6

ABSOLUTE MAXIMUM RATINGS

Ratings at 25°C, unless otherwise noted.

Table 7.

Parameter	Rating
Supply Voltage	40.0 V
Output Short-Circuit Duration to GND	Indefinite
Storage Temperature Range	-65°C to +150°C
Operating Temperature Range	-40°C to +125°C
Junction Temperature Range	-65°C to +150°C
Lead Temperature Range (Soldering, 60 sec)	300°C

Stresses above those listed under Absolute Maximum Ratings may cause permanent damage to the device. This is a stress rating only; functional operation of the device at these or any other conditions above those indicated in the operational section of this specification is not implied. Exposure to absolute maximum rating conditions for extended periods may affect device reliability.

THERMAL RESISTANCE

θ_{JA} is specified for the worst-case conditions, that is, a device soldered in a circuit board for surface-mount packages.

Table 8. Thermal Resistance

Package Type	θ_{JA}	θ_{JC}	Unit
5-Lead SC70 (KS-5)	376	189	°C/W
5-Lead TSOT (UJ-5)	230	146	°C/W
8-Lead SOIC (R-8)	130	43	°C/W

ESD CAUTION



ESD (electrostatic discharge) sensitive device. Charged devices and circuit boards can discharge without detection. Although this product features patented or proprietary protection circuitry, damage may occur on devices subjected to high energy ESD. Therefore, proper ESD precautions should be taken to avoid performance degradation or loss of functionality.

TERMINOLOGY

Temperature Coefficient

The change of output voltage with respect to operating temperature changes normalized by the output voltage at 25°C. This parameter is expressed in ppm/°C and can be determined by the following equation:

$$TCV_o \left[\frac{ppm}{^\circ C} \right] = \frac{V_o(T_2) - V_o(T_1)}{V_o(25^\circ C) \times (T_2 - T_1)} \times 10^6$$

where:

$V_o(25^\circ C) = V_o$ at 25°C.

$V_o(T_1) = V_o$ at Temperature 1.

$V_o(T_2) = V_o$ at Temperature 2.

Line Regulation

The change in output voltage due to a specified change in input voltage. This parameter accounts for the effects of self-heating. Line regulation is expressed in either percent per volt, parts-per-million per volt, or microvolts per volt change in input voltage.

Load Regulation

The change in output voltage due to a specified change in load current. This parameter accounts for the effects of self-heating. Load regulation is expressed in either microvolts per milliamper, parts-per-million per milliamper, or ohms of dc output resistance.

Long-Term Stability

Typical shift of output voltage at 25°C on a sample of parts subjected to a test of 1000 hours at 25°C.

$$\Delta V_o = V_o(t_0) - V_o(t_1)$$

$$\Delta V_o [ppm] = \frac{V_o(t_0) - V_o(t_1)}{V_o(t_0)} \times 10^6$$

where:

$V_o(t_0) = V_o$ at 25°C at Time 0.

$V_o(t_1) = V_o$ at 25°C after 100 hours of operation at 25°C.

The majority of the shift is seen in the first 200 hours, and as time goes by, the drift decreases significantly. This drift is much

smaller for the subsequent 1000 hours of time points than for the first.

Thermal Hysteresis

The change of output voltage after the device is cycled through temperatures from +25°C to -40°C to +125°C and back to +25°C. This is a typical value from a sample of parts put through such a cycle.

$$V_{O_HYS} = V_o(25^\circ C) - V_{O_TC}$$

$$V_{O_HYS} [ppm] = \frac{V_o(25^\circ C) - V_{O_TC}}{V_o(25^\circ C)} \times 10^6$$

where:

$V_o(25^\circ C) = V_o$ at 25°C.

$V_{O_TC} = V_o$ at 25°C after temperature cycle at +25°C to -40°C to +125°C and back to +25°C.

Input Capacitor

Input capacitors are not required on the ADR01/ADR02/ADR03/ADR06. There is no limit to the value of the capacitor used on the input, but a 1 μF to 10 μF capacitor on the input improves transient response in applications where the supply suddenly changes. An additional 0.1 μF in parallel also helps to reduce noise from the supply.

Output Capacitor

The ADR01/ADR02/ADR03/ADR06 do not require output capacitors for stability under any load condition. An output capacitor, typically 0.1 μF, filters out any low-level noise voltage and does not affect the operation of the part. Alternatively, the load transient response can be improved with an additional 1 μF to 10 μF output capacitor in parallel. A capacitor here acts as a source of stored energy for a sudden increase in load current. The only parameter that degrades by adding an output capacitor is the turn-on time, and it depends on the size of the capacitor chosen.

TYPICAL PERFORMANCE CHARACTERISTICS

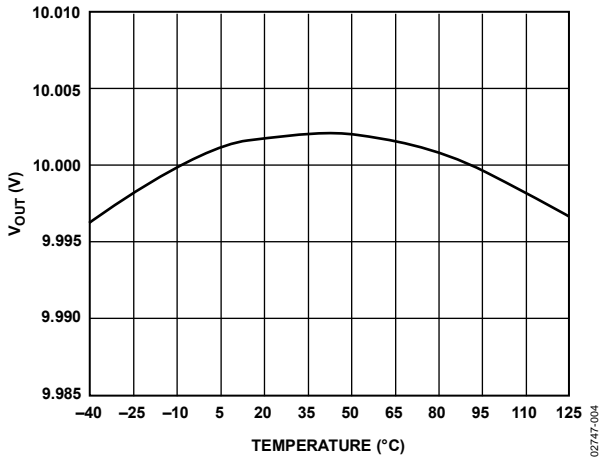

Figure 4. ADR01 Typical Output Voltage vs. Temperature

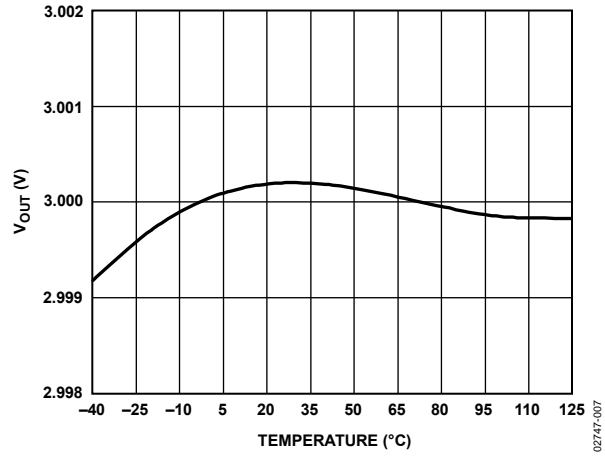

Figure 7. ADR06 Typical Output Voltage vs. Temperature

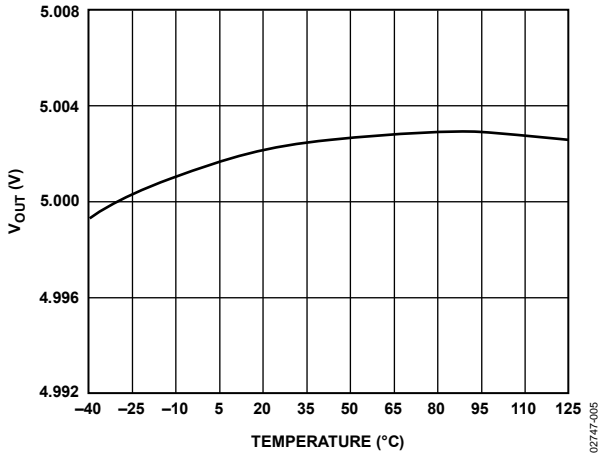

Figure 5. ADR02 Typical Output Voltage vs. Temperature

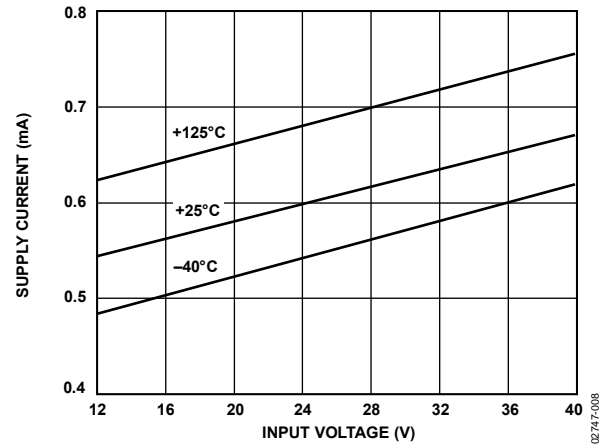

Figure 8. ADR01 Supply Current vs. Input Voltage

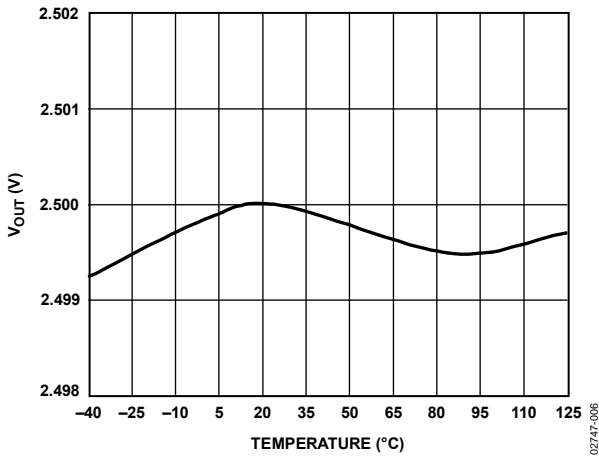

Figure 6. ADR03 Typical Output Voltage vs. Temperature

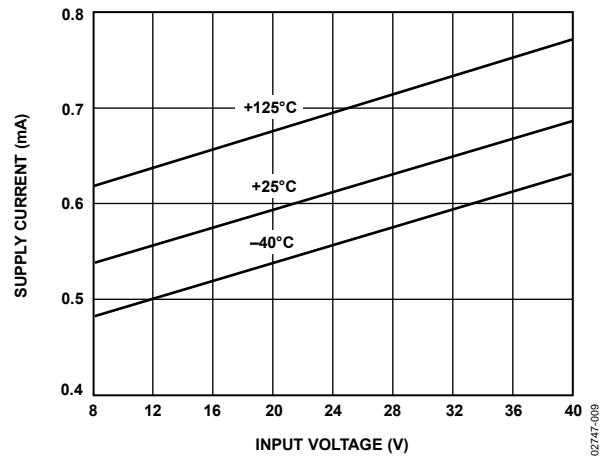

Figure 9. ADR02 Supply Current vs. Input Voltage

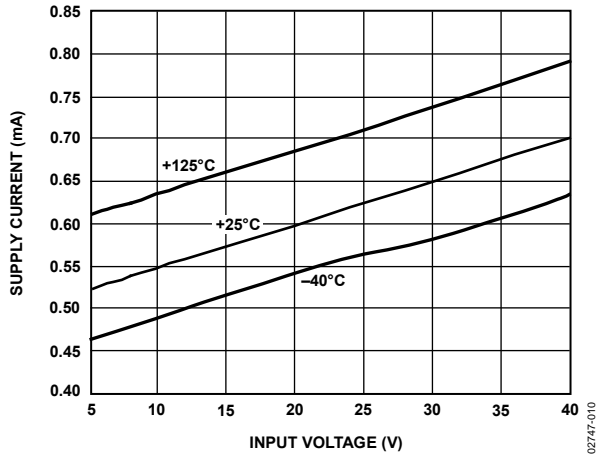

Figure 10. ADR03 Supply Current vs. Input Voltage

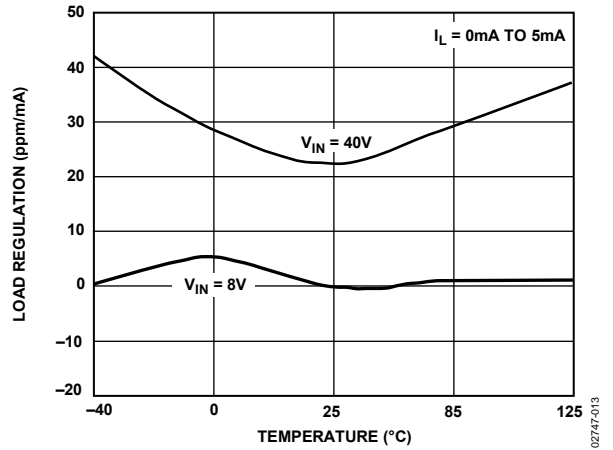

Figure 13. ADR02 Load Regulation vs. Temperature

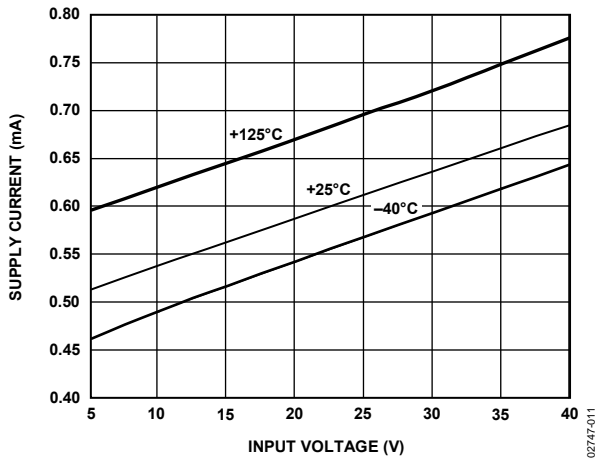

Figure 11. ADR06 Supply Current vs. Input Voltage

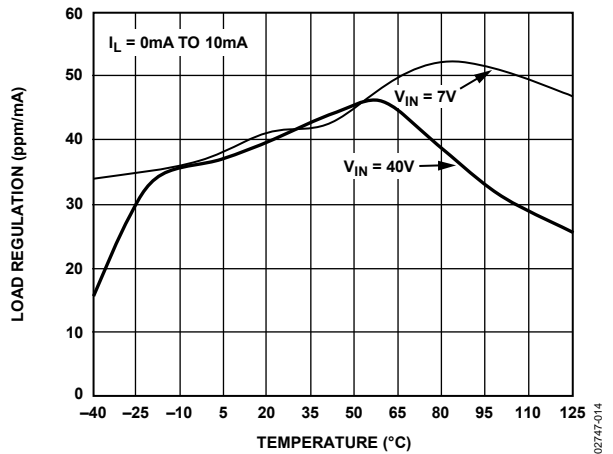

Figure 14. ADR03 Load Regulation vs. Temperature

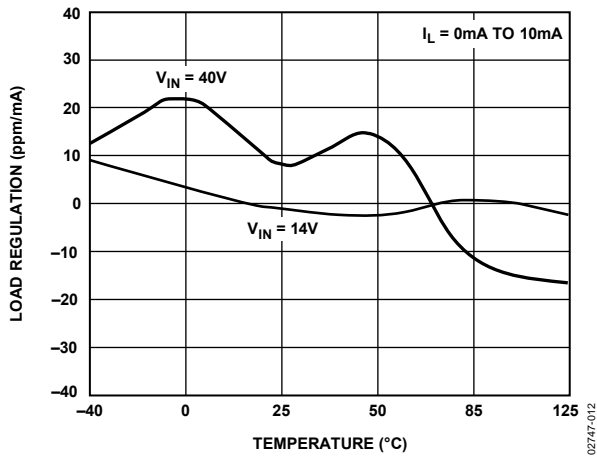

Figure 12. ADR01 Load Regulation vs. Temperature

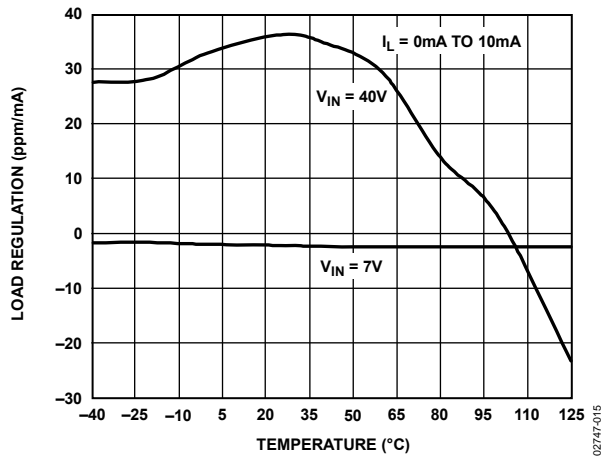

Figure 15. ADR06 Load Regulation vs. Temperature

ADR01/ADR02/ADR03/ADR06

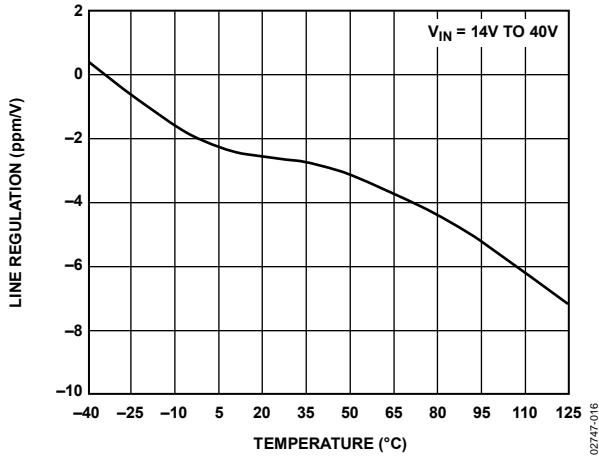

Figure 16. ADR01 Line Regulation vs. Temperature

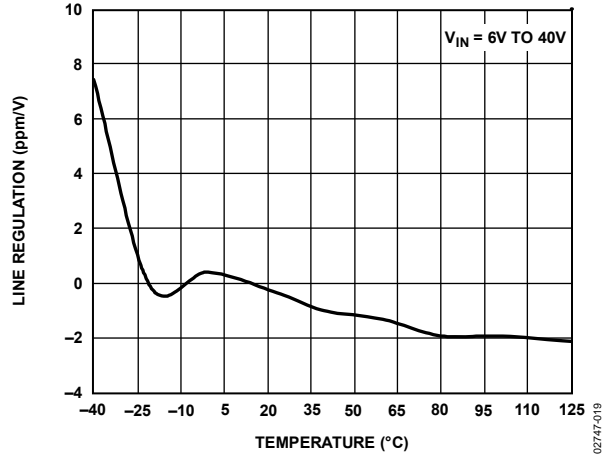

Figure 19. ADR06 Line Regulation vs. Temperature

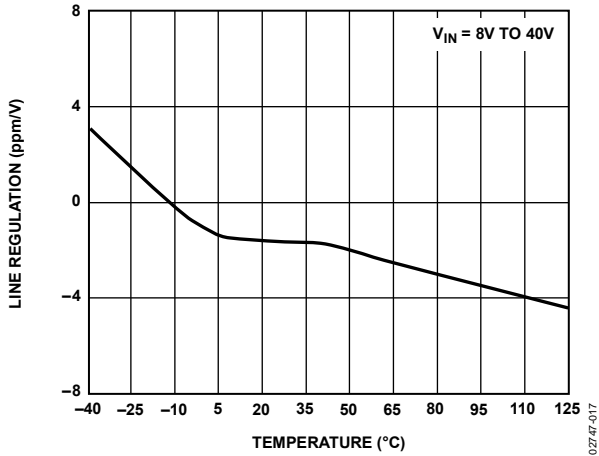

Figure 17. ADR02 Line Regulation vs. Temperature

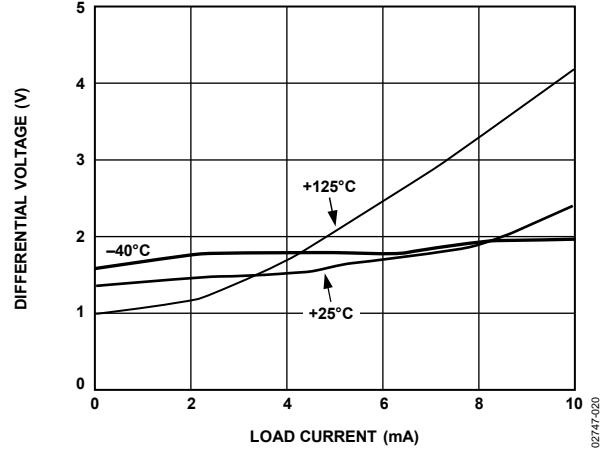

Figure 20. ADR01 Minimum Input-Output Voltage Differential vs. Load Current

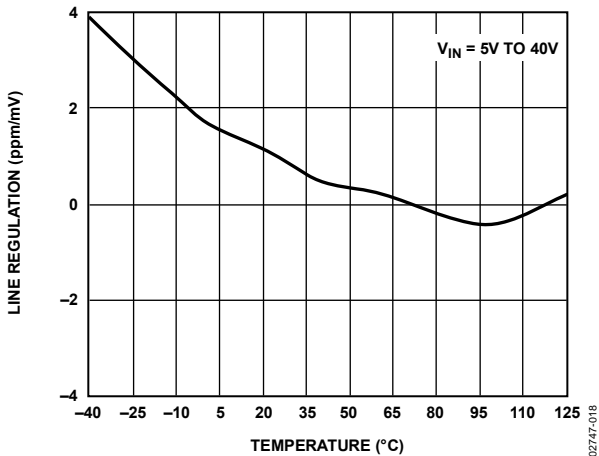

Figure 18. ADR03 Line Regulation vs. Temperature

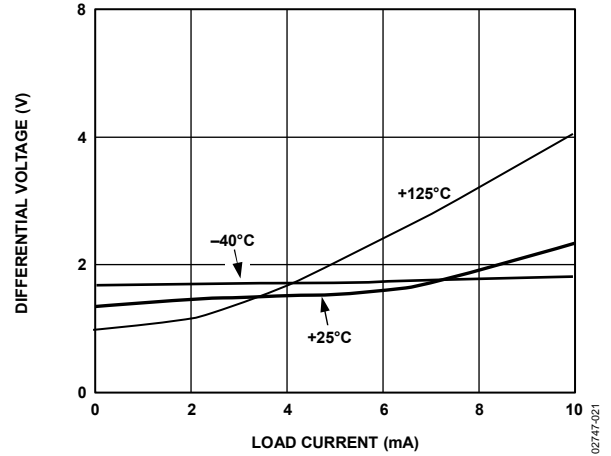

Figure 21. ADR02 Minimum Input-Output Voltage Differential vs. Load Current

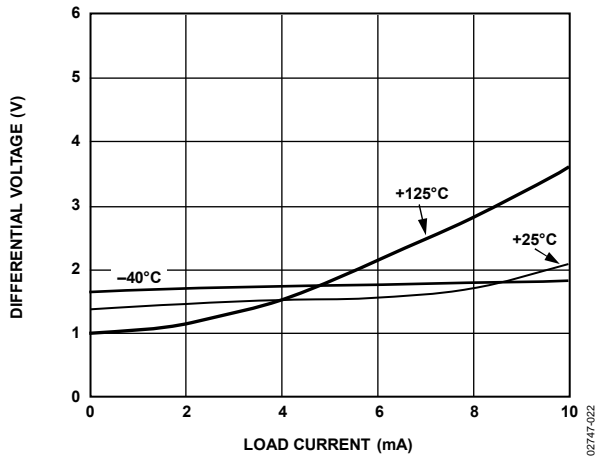

Figure 22. ADR03 Minimum Input-Output Voltage Differential vs. Load Current

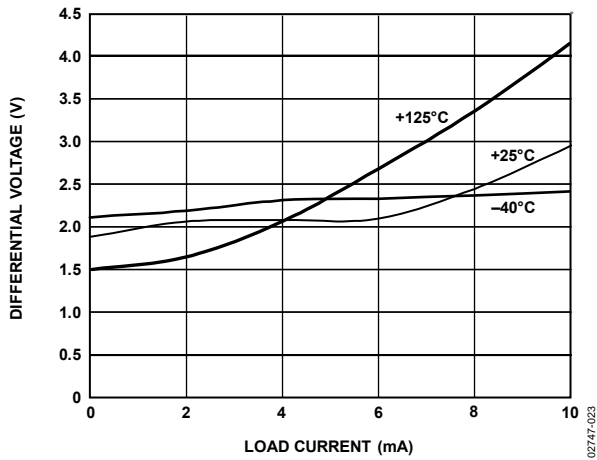

Figure 23. ADR06 Minimum Input-Output Voltage Differential vs. Load Current

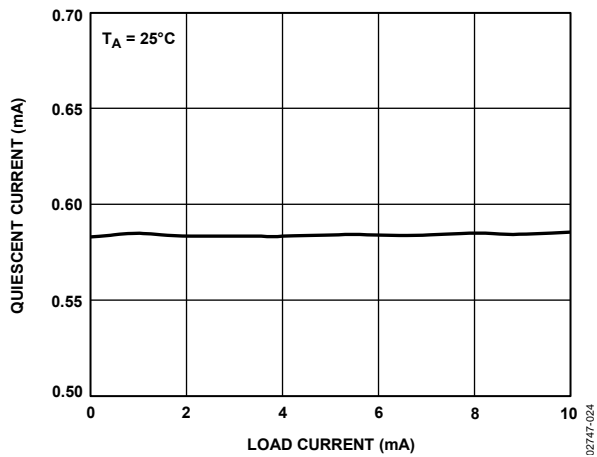

Figure 24. ADR01 Quiescent Current vs. Load Current

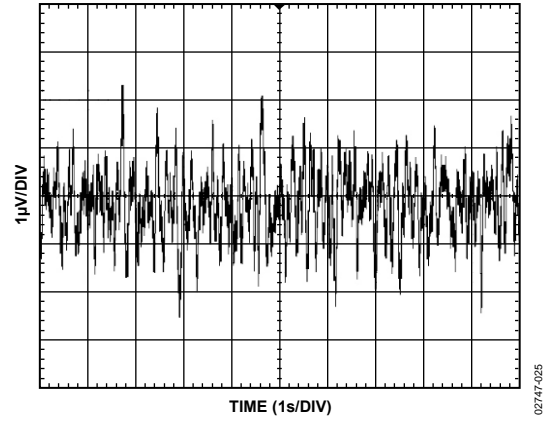

Figure 25. ADR02 Typical Noise Voltage 0.1 Hz to 10.0 Hz

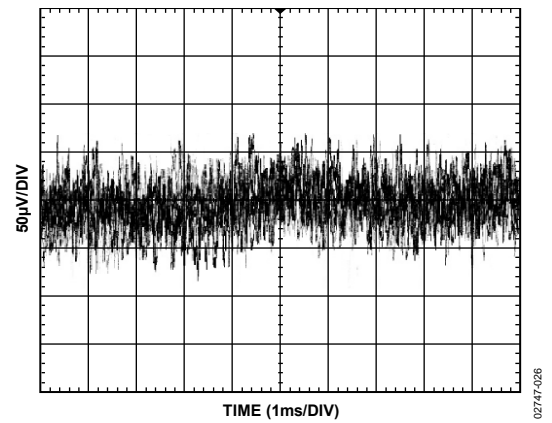

Figure 26. ADR02 Typical Noise Voltage 10 Hz to 10 kHz

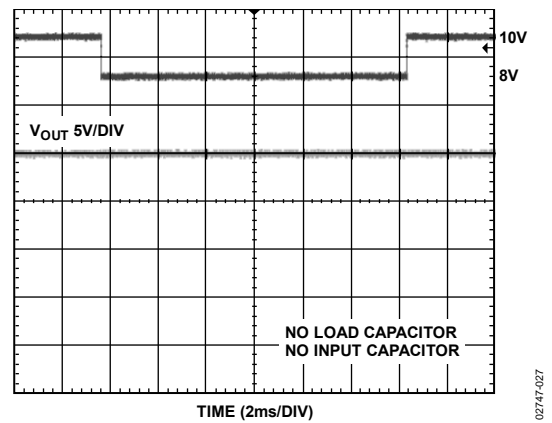

Figure 27. ADR02 Line Transient Response

ADR01/ADR02/ADR03/ADR06

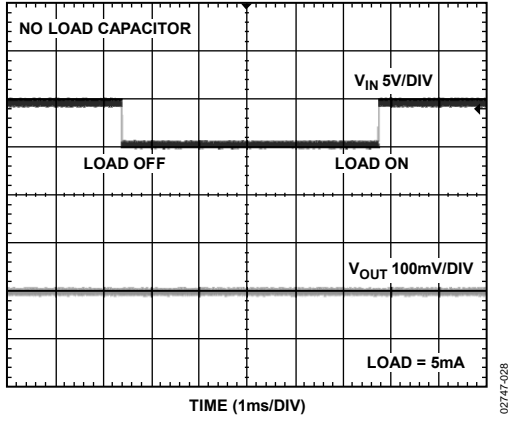

Figure 28. ADR02 Load Transient Response

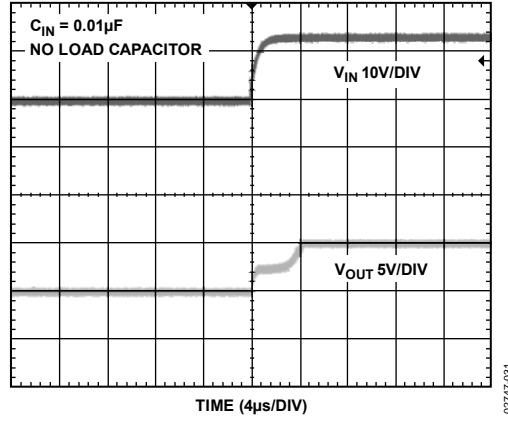

Figure 31. ADR02 Turn-On Response

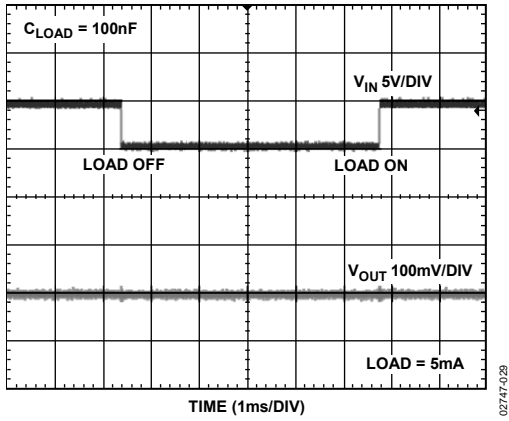

Figure 29. ADR02 Load Transient Response

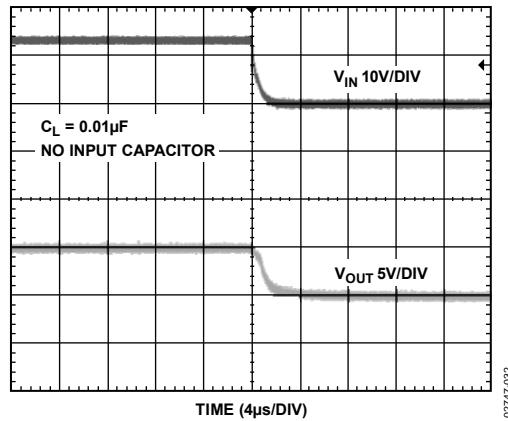

Figure 32. ADR02 Turn-Off with No Input Capacitor

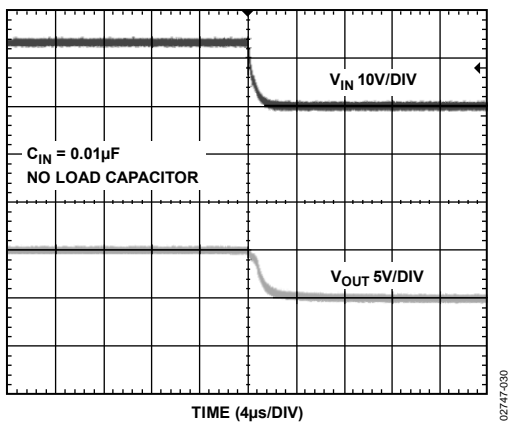

Figure 30. ADR02 Turn-Off Response

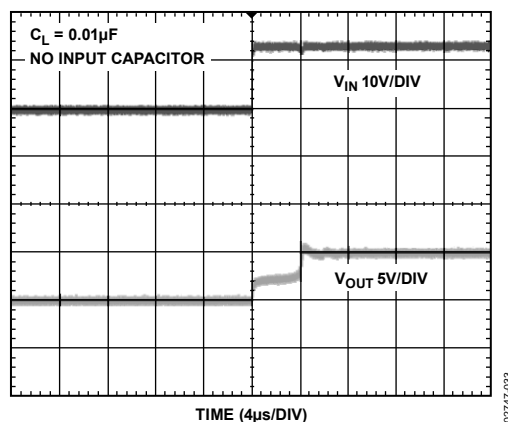

Figure 33. ADR02 Turn-Off with No Input Capacitor

APPLICATIONS

The ADR01/ADR02/ADR03/ADR06 are high precision, low drift 10.0 V, 5.0 V, 2.5 V, and 3.0 V voltage references available in an ultracompact footprint. The 8-lead SOIC versions of the devices are drop-in replacements of the REF01/REF02/REF03 sockets with improved cost and performance.

These devices are standard band gap references (see Figure 35). The band gap cell contains two NPN transistors (Q18 and Q19) that differ in emitter area by 2 \times . The difference in their V_{BE} produces a proportional-to-absolute temperature current (PTAT) in R14, and, when combined with the V_{BE} of Q19, produces a band gap voltage, V_{BG} , that is almost constant in temperature. With an internal op amp and the feedback network of R5 and R6, V_O is set precisely at 10.0 V, 5.0 V, 2.5 V, and 3.0 V for the ADR01, ADR02, ADR06, and ADR03, respectively. Precision laser trimming of the resistors and other proprietary circuit techniques are used to further enhance the initial accuracy, temperature curvature, and drift performance of the ADR01/ADR02/ADR03/ADR06.

The PTAT voltage is made available at the TEMP pin of the ADR01/ADR02/ADR03/ADR06. It has a stable 1.96 mV/ $^{\circ}$ C temperature coefficient, such that users can estimate the temperature change of the device by knowing the voltage change at the TEMP pin.

APPLYING THE ADR01/ADR02/ADR03/ADR06

The devices can be used without any external components to achieve the specified performance. Because of the internal op amp amplifying the band gap cell to 10.0 V/5.0 V/2.5 V/3.0 V, power supply decoupling helps the transient response of the ADR01/ADR02/ADR03/ADR06. As a result, a 0.1 μ F ceramic type decoupling capacitor should be applied as close as possible to the input and output pins of the device. An optional 1 μ F to 10 μ F bypass capacitor can also be applied at the V_{IN} node to maintain the input under transient disturbance.

Output Adjustment

The ADR01/ADR02/ADR03/ADR06 trim terminal can be used to adjust the output voltage over a nominal voltage. This feature allows a system designer to trim system errors by setting the reference to a voltage other than 10.0 V/5.0 V/2.5 V/3.0 V. For finer adjustment, add a series resistor of 470 k Ω . With the configuration shown in Figure 36, the ADR01 can be adjusted from 9.70 V to 10.05 V, the ADR02 can be adjusted from 4.95 V to 5.02 V, the ADR06 can be adjusted from 2.8 V to 3.3 V, and the ADR03 can be adjusted from 2.3 V to 2.8 V. Adjustment of the output does not significantly affect the temperature performance of the device, provided the temperature coefficients of the resistors are relatively low.

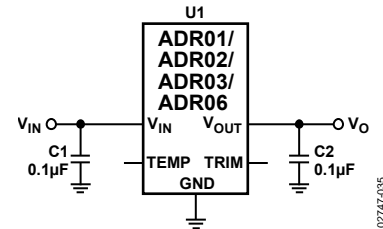

Figure 34. Basic Configuration

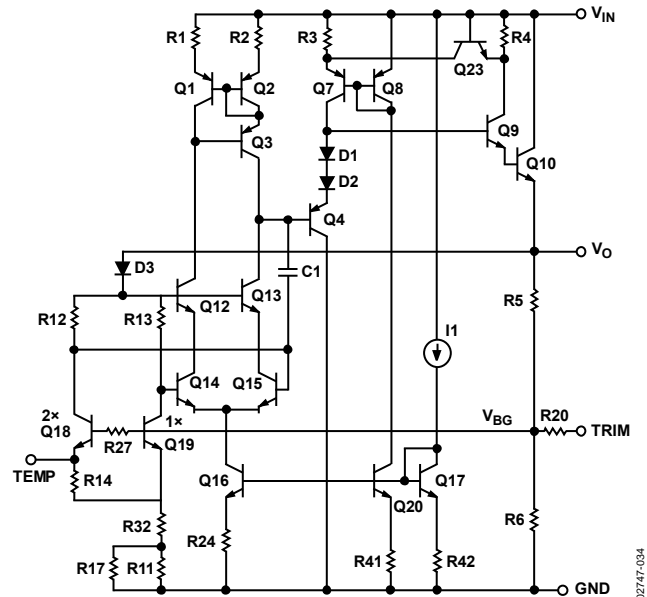

Figure 35. Simplified Schematic Diagram

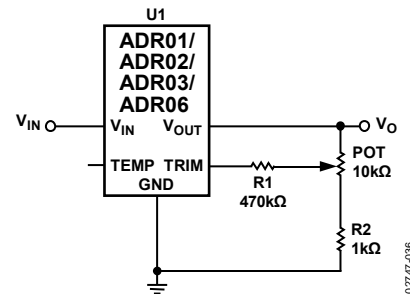

Figure 36. Optional Trim Adjustment

Temperature Monitoring

As described at the end of the Applications section, the ADR01/ADR02/ADR03/ADR06 provide a TEMP output (Pin 1 in Figure 1 and Pin 3 in Figure 2) that varies linearly with temperature. This output can be used to monitor the temperature change in the system. The voltage at V_{TEMP} is approximately 550 mV at 25 $^{\circ}$ C, and the temperature coefficient is approximately 1.96 mV/ $^{\circ}$ C (see Figure 37). A voltage change of 39.2 mV at the TEMP pin corresponds to a 20 $^{\circ}$ C change in temperature.

ADR01/ADR02/ADR03/ADR06

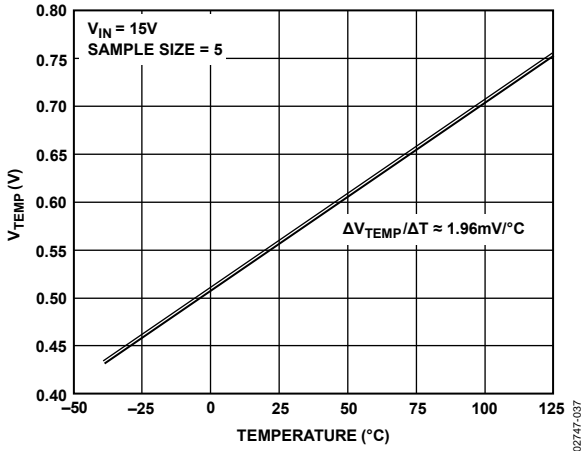

Figure 37. Voltage at TEMP Pin vs. Temperature

The TEMP function is provided as a convenience rather than a precise feature. Because the voltage at the TEMP node is acquired from the band gap core, current pulling from this pin has a significant effect on V_{OUT} . Care must be taken to buffer the TEMP output with a suitable low bias current op amp, such as the AD8601, AD820, or OP1177, all of which result in less than a 100 μV change in ΔV_{OUT} (see Figure 38). Without buffering, even tens of microamps drawn from the TEMP pin can cause V_{OUT} to fall out of specification.

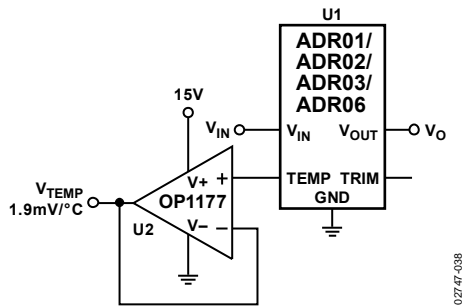

Figure 38. Temperature Monitoring

NEGATIVE REFERENCE

Without using any matching resistors, a negative reference can be configured, as shown in Figure 39. For the ADR01, the voltage difference between V_{OUT} and GND is 10.0 V. Because V_{OUT} is at virtual ground, U2 closes the loop by forcing the GND pin to be the negative reference node. U2 should be a precision op amp with a low offset voltage characteristic.

LOW COST CURRENT SOURCE

Unlike most references, the ADR01/ADR02/ADR03/ADR06 employ an NPN Darlington in which the quiescent current remains constant with respect to the load current, as shown in Figure 24. As a result, a current source can be configured as shown in Figure 40 where $I_{SET} = (V_{OUT} - V_L)/R_{SET}$. I_L is simply the sum of I_{SET} and I_Q . Although simple, I_Q varies typically from 0.55 mA to 0.65 mA, limiting this circuit to general-purpose applications.

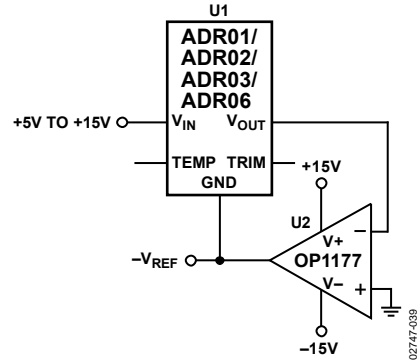

Figure 39. Negative Reference

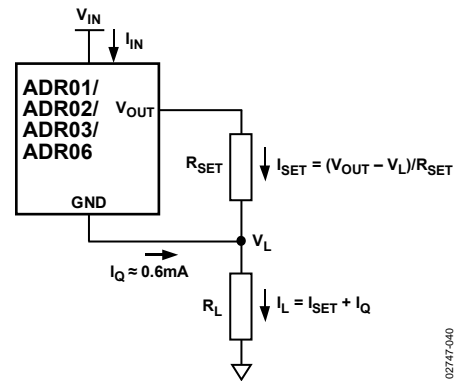

Figure 40. Low Cost Current Source

PRECISION CURRENT SOURCE WITH ADJUSTABLE OUTPUT

Alternatively, a precision current source can be implemented with the circuit shown in Figure 41. By adding a mechanical or digital potentiometer, this circuit becomes an adjustable current source. If a digital potentiometer is used, the load current is simply the voltage across Terminal B to Terminal W of the digital potentiometer divided by R_{SET} .

$$I_L = \frac{V_{REF} \times D}{R_{SET}} \quad (1)$$

where D is the decimal equivalent of the digital potentiometer input code.

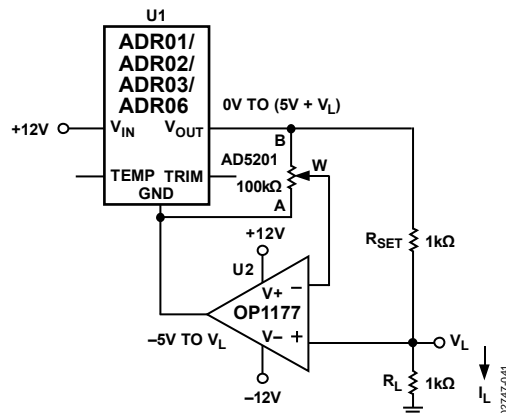

Figure 41. Programmable 0 mA to 5 mA Current Source

To optimize the resolution of this circuit, dual-supply op amps should be used because the ground potential of ADR02 can swing from -5.0 V at zero scale to V_L at full scale of the potentiometer setting.

PROGRAMMABLE 4 mA TO 20 mA CURRENT TRANSMITTER

Because of their precision, adequate current handling, and small footprint, the devices are suitable as the reference sources for many high performance converter circuits. One of these applications is the multichannel 16-bit, 4 mA to 20 mA current transmitter in the industrial control market (see Figure 42). This circuit employs a Howland current pump at the output to yield better efficiency, a lower component count, and a higher voltage compliance than the conventional design with op amps and MOSFETs. In this circuit, if the resistors are matched such that $R1 = R1'$, $R2 = R2'$, $R3 = R3'$, the load current is

$$I_L = \frac{(R2 + R3)/R1}{R3'} \times \frac{V_{REF} \times D}{2^N} \quad (2)$$

where D is similarly the decimal equivalent of the DAC input code and N is the number of bits of the DAC.

According to Equation 2, $R3'$ can be used to set the sensitivity. $R3'$ can be made as small as necessary to achieve the current needed within U4 output current driving capability. Alternatively, other resistors can be kept high to conserve power.

In this circuit, the AD8512 is capable of delivering 20 mA of current, and the voltage compliance approaches 15.0 V.

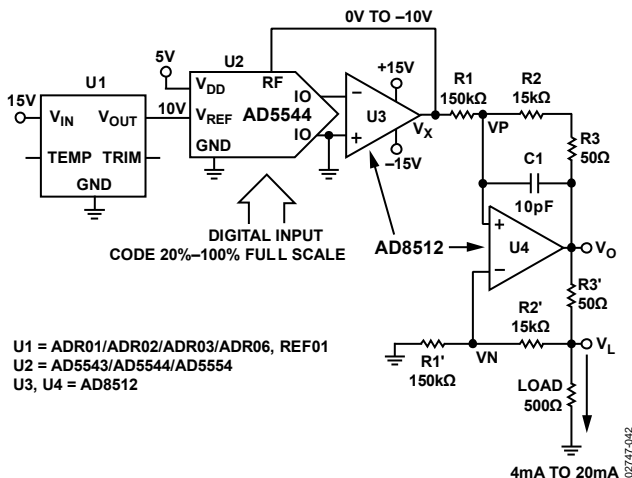

Figure 42. Programmable 4 mA to 20 mA Transmitter

The Howland current pump yields a potentially infinite output impedance, that is highly desirable, but resistance matching is critical in this application. The output impedance can be determined using Equation 3. As shown by this equation, if the resistors are perfectly matched, Z_o is infinite. Alternatively, if they are not matched, Z_o is either positive or negative. If the

latter is true, oscillation can occur. For this reason, connect Capacitor C1 in the range of 1 pF to 10 pF between VP and the output terminal of U4 to filter any oscillation.

$$Z_o = \frac{V_t}{I_t} = \frac{R1'}{\left(\frac{R1'R2}{R1R2'} - 1\right)} \quad (3)$$

In this circuit, an ADR01 provides the stable 10.000 V reference for the AD5544 quad 16-bit DAC. The resolution of the adjustable current is $0.3\ \mu\text{A}/\text{step}$; the total worst-case INL error is merely 4 LSBs. Such error is equivalent to $1.2\ \mu\text{A}$ or a 0.006% system error, which is well below most systems' requirements. The result is shown in Figure 43 with measurement taken at 25°C and 70°C; total system error of 4 LSBs at both 25°C and 70°C.

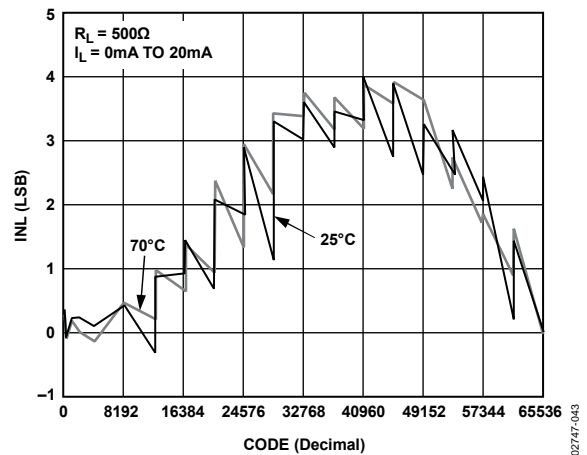

Figure 43. Result of Programmable 4 mA to 20 mA Current Transmitter

PRECISION BOOSTED OUTPUT REGULATOR

A precision voltage output with boosted current capability can be realized with the circuit shown in Figure 44. In this circuit, U2 forces V_o to be equal to V_{REF} by regulating the turn-on of N1, thereby making the load current furnished by V_{IN} . In this configuration, a 50 mA load is achievable at V_{IN} of 15.0 V. Moderate heat is generated on the MOSFET, and higher current can be achieved with a replacement of a larger device. In addition, for a heavy capacitive load with a fast edging input signal, a buffer should be added at the output to enhance the transient response.

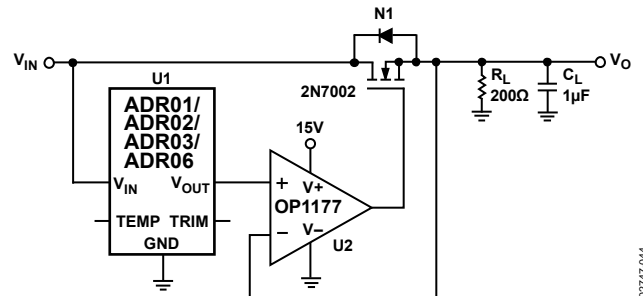
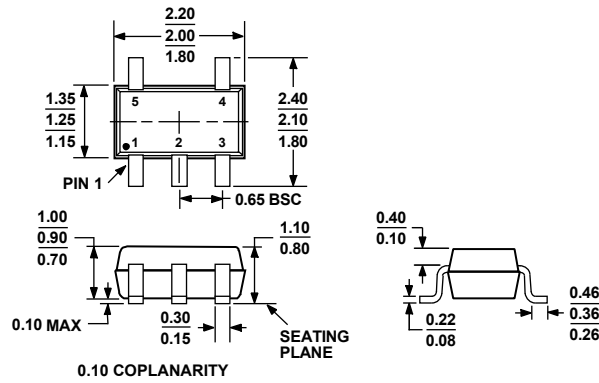

Figure 44. Precision Boosted Output Regulator

OUTLINE DIMENSIONS



COMPLIANT TO JEDEC STANDARDS MO-203-AA

Figure 45. 5-Lead Thin Shrink Small Outline Transistor Package [SC70] (KS-5)
Dimensions shown in millimeters

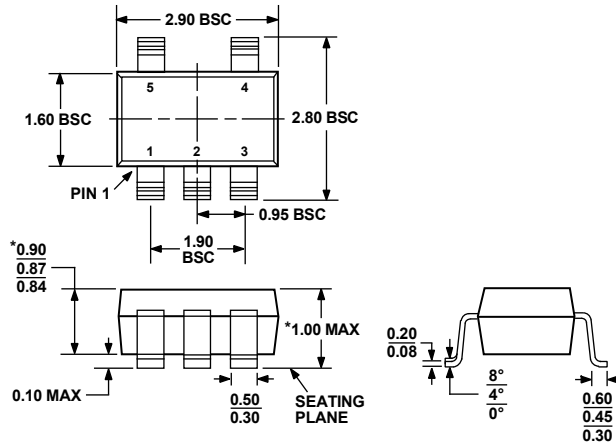

*COMPLIANT TO JEDEC STANDARDS MO-193-AB WITH THE EXCEPTION OF PACKAGE HEIGHT AND THICKNESS.

Figure 46. 5-Lead Thin Small Outline Transistor Package [TSOT] (UJ-5)
Dimensions shown in millimeters

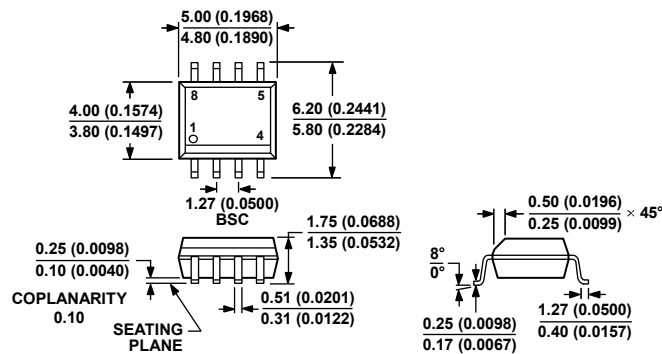

COMPLIANT TO JEDEC STANDARDS MS-012-AA
CONTROLLING DIMENSIONS ARE IN MILLIMETERS; INCH DIMENSIONS (IN PARENTHESES) ARE ROUNDED-OFF MILLIMETER EQUIVALENTS FOR REFERENCE ONLY AND ARE NOT APPROPRIATE FOR USE IN DESIGN.

Figure 47. 8-Lead Standard Small Outline Package [SOIC_N] Narrow Body (R-8)
Dimensions shown in millimeters and (inches)

012407-A

ORDERING GUIDES

ADR01 Ordering Guide

Model	Output Voltage V _o (V)	Initial Accuracy		Temperature Coefficient (ppm/°C)	Temperature Range	Package Description	Package Option	Ordering Quantity	Branding
		(mV)	(%)						
ADR01AR	10	10	0.1	10	-40°C to +125°C	8-Lead SOIC-N	R-8	98	
ADR01AR-REEL7	10	10	0.1	10	-40°C to +125°C	8-Lead SOIC-N	R-8	1,000	
ADR01ARZ ¹	10	10	0.1	10	-40°C to +125°C	8-Lead SOIC-N	R-8	98	
ADR01ARZ-REEL7 ¹	10	10	0.1	10	-40°C to +125°C	8-Lead SOIC-N	R-8	1,000	
ADR01BR	10	5	0.05	3	-40°C to +125°C	8-Lead SOIC-N	R-8	98	
ADR01BR-REEL7	10	5	0.05	3	-40°C to +125°C	8-Lead SOIC-N	R-8	1,000	
ADR01BRZ ¹	10	5	0.05	3	-40°C to +125°C	8-Lead SOIC-N	R-8	98	
ADR01BRZ-REEL7 ¹	10	5	0.05	3	-40°C to +125°C	8-Lead SOIC-N	R-8	1,000	
ADR01AUJ-REEL7	10	10	0.1	25	-40°C to +125°C	5-Lead TSOT	UJ-5	3,000	R8A
ADR01AUJ-R2	10	10	0.1	25	-40°C to +125°C	5-Lead TSOT	UJ-5	250	R8A
ADR01AUJZ-REEL7 ¹	10	10	0.1	25	-40°C to +125°C	5-Lead TSOT	UJ-5	3,000	R1E
ADR01BUJ-REEL7	10	5	0.05	9	-40°C to +125°C	5-Lead TSOT	UJ-5	3,000	R8B
ADR01BUJ-R2	10	5	0.05	9	-40°C to +125°C	5-Lead TSOT	UJ-5	250	R8B
ADR01BUJZ-REEL7 ¹	10	5	0.05	9	-40°C to +125°C	5-Lead TSOT	UJ-5	3,000	R1F
ADR01AKS-REEL7	10	10	0.1	25	-40°C to +125°C	5-Lead SC70	KS-5	3,000	R8A
ADR01AKS-R2	10	10	0.1	25	-40°C to +125°C	5-Lead SC70	KS-5	250	R8A
ADR01AKSZ-REEL7 ¹	10	10	0.1	25	-40°C to +125°C	5-Lead SC70	KS-5	3,000	R1E
ADR01BKS-REEL7	10	5	0.05	9	-40°C to +125°C	5-Lead SC70	KS-5	3,000	R8B
ADR01BKS-R2	10	5	0.05	9	-40°C to +125°C	5-Lead SC70	KS-5	250	R8B
ADR01BKSZ-REEL7 ¹	10	5	0.05	9	-40°C to +125°C	5-Lead SC70	KS-5	3,000	R1F
ADR01CRZ ¹	10	10	0.1	40	-40°C to +125°C	8-Lead SOIC-N	R-8	98	
ADR01CRZ-REEL ¹	10	10	0.1	40	-40°C to +125°C	8-Lead SOIC-N	R-8	2,500	
ADR01NBC	10	5	0.05	10 (typ)		Die		360	

¹ Z = RoHS Compliant Part.

ADR01/ADR02/ADR03/ADR06

ADR02 Ordering Guide

Model	Output Voltage V _o (V)	Initial Accuracy		Temperature Coefficient (ppm/°C)	Temperature Range	Package Description	Package Option	Ordering Quantity	Branding
		(mV)	(%)						
ADR02AR	5	5	0.1	10	-40°C to +125°C	8-Lead SOIC-N	R-8	98	
ADR02AR-REEL	5	5	0.1	10	-40°C to +125°C	8-Lead SOIC-N	R-8	2,500	
ADR02AR-REEL7	5	5	0.1	10	-40°C to +125°C	8-Lead SOIC-N	R-8	1,000	
ADR02ARZ ¹	5	5	0.1	10	-40°C to +125°C	8-Lead SOIC-N	R-8	98	
ADR02ARZ-REEL ¹	5	5	0.1	10	-40°C to +125°C	8-Lead SOIC-N	R-8	2,500	
ADR02ARZ-REEL7 ¹	5	5	0.1	10	-40°C to +125°C	8-Lead SOIC-N	R-8	2,500	
ADR02BR	5	3	0.06	3	-40°C to +125°C	8-Lead SOIC-N	R-8	98	
ADR02BR-REEL7	5	3	0.06	3	-40°C to +125°C	8-Lead SOIC-N	R-8	1,000	
ADR02BRZ ¹	5	3	0.06	3	-40°C to +125°C	8-Lead SOIC-N	R-8	98	
ADR02BRZ-REEL7 ¹	5	3	0.06	3	-40°C to +125°C	8-Lead SOIC-N	R-8	1,000	
ADR02AUJ-REEL7	5	5	0.1	25	-40°C to +125°C	5-Lead TSOT	UJ-5	3,000	R9A
ADR02AUJ-R2	5	5	0.1	25	-40°C to +125°C	5-Lead TSOT	UJ-5	250	R9A
ADR02AUJZ-REEL7 ¹	5	5	0.1	25	-40°C to +125°C	5-Lead TSOT	UJ-5	3,000	R1G
ADR02BUJ-REEL7	5	3	0.06	9	-40°C to +125°C	5-Lead TSOT	UJ-5	3,000	R9B
ADR02BUJ-R2	5	3	0.06	9	-40°C to +125°C	5-Lead TSOT	UJ-5	250	R9B
ADR02BUJZ-R2 ¹	5	3	0.06	9	-40°C to +125°C	5-Lead TSOT	UJ-5	250	R9B
ADR02BUJZ-REEL7 ¹	5	3	0.06	9	-40°C to +125°C	5-Lead TSOT	UJ-5	3,000	R1H
ADR02AKS-REEL7	5	5	0.1	25	-40°C to +125°C	5-Lead SC70	KS-5	3,000	R9A
ADR02AKS-R2	5	5	0.1	25	-40°C to +125°C	5-Lead SC70	KS-5	250	R9A
ADR02AKSZ-REEL7 ¹	5	5	0.1	25	-40°C to +125°C	5-Lead SC70	KS-5	3,000	R1G
ADR02BKS-REEL7	5	3	0.06	9	-40°C to +125°C	5-Lead SC70	KS-5	3,000	R9B
ADR02BKS-R2	5	3	0.06	9	-40°C to +125°C	5-Lead SC70	KS-5	250	R9B
ADR02BKSZ-REEL7 ¹	5	3	0.06	9	-40°C to +125°C	5-Lead SC70	KS-5	3,000	R1H
ADR02CRZ ¹	5	5	0.1	40	-40°C to +125°C	8-Lead SOIC-N	R-8	98	
ADR02CRZ-REEL ¹	5	5	0.1	40	-40°C to +125°C	8-Lead SOIC-N	R-8	2,500	

¹ Z = RoHS Compliant Part.

ADR03 Ordering Guide

Model	Output Voltage V _o (V)	Initial Accuracy		Temperature Coefficient (ppm/°C)	Temperature Range	Package Description	Package Option	Ordering Quantity	Branding
		(mV)	(%)						
ADR03AR	2.5	5	0.2	10	-40°C to +125°C	8-Lead SOIC-N	R-8	98	
ADR03AR-REEL7	2.5	5	0.2	10	-40°C to +125°C	8-Lead SOIC-N	R-8	1,000	
ADR03ARZ ¹	2.5	5	0.2	10	-40°C to +125°C	8-Lead SOIC-N	R-8	98	
ADR03ARZ-REEL7 ¹	2.5	5	0.2	10	-40°C to +125°C	8-Lead SOIC-N	R-8	1,000	
ADR03BR	2.5	2.5	0.1	3	-40°C to +125°C	8-Lead SOIC-N	R-8	98	
ADR03BR-REEL7	2.5	2.5	0.1	3	-40°C to +125°C	8-Lead SOIC-N	R-8	1,000	
ADR03BRZ ¹	2.5	2.5	0.1	3	-40°C to +125°C	8-Lead SOIC-N	R-8	98	
ADR03BRZ-REEL7 ¹	2.5	2.5	0.1	3	-40°C to +125°C	8-Lead SOIC-N	R-8	1,000	
ADR03AUJ-REEL7	2.5	5	0.2	25	-40°C to +125°C	5-Lead TSOT	UJ-5	3,000	RFA
ADR03AUJ-R2	2.5	5	0.2	25	-40°C to +125°C	5-Lead TSOT	UJ-5	250	RFA
ADR03AUJZ-REEL7 ¹	2.5	5	0.2	25	-40°C to +125°C	5-Lead TSOT	UJ-5	3,000	R1J
ADR03BUJ-REEL7	2.5	2.5	0.1	9	-40°C to +125°C	5-Lead TSOT	UJ-5	3,000	RFB
ADR03BUJ-R2	2.5	2.5	0.1	9	-40°C to +125°C	5-Lead TSOT	UJ-5	250	RFB
ADR03BUJZ-REEL7 ¹	2.5	2.5	0.1	9	-40°C to +125°C	5-Lead TSOT	UJ-5	3,000	R1K
ADR03AKS-REEL7	2.5	5	0.2	25	-40°C to +125°C	5-Lead SC70	KS-5	3,000	RFA
ADR03AKS-R2	2.5	5	0.2	25	-40°C to +125°C	5-Lead SC70	KS-5	250	RFA
ADR03AKSZ-REEL7 ¹	2.5	5	0.2	25	-40°C to +125°C	5-Lead SC70	KS-5	3,000	R1J
ADR03BKS-REEL7	2.5	2.5	0.1	9	-40°C to +125°C	5-Lead SC70	KS-5	3,000	RFB
ADR03BKS-R2	2.5	2.5	0.1	9	-40°C to +125°C	5-Lead SC70	KS-5	250	RFB
ADR03BKSZ-REEL7 ¹	2.5	2.5	0.1	9	-40°C to +125°C	5-Lead SC70	KS-5	3,000	R1K
ADR03CRZ ¹	2.5	5	0.1	40	-40°C to +125°C	8-Lead SOIC-N	R-8	98	
ADR03CRZ-REEL ¹	2.5	5	0.1	40	-40°C to +125°C	8-Lead SOIC-N	R-8	2,500	
ADR03NBC	2.5	2.5	0.1	10 (typ)		Die		360	

¹ Z = RoHS Compliant Part.

ADR01/ADR02/ADR03/ADR06

ADR06 Ordering Guide

Model	Output Voltage V _o (V)	Initial Accuracy		Temperature Coefficient (ppm/°C)	Temperature Range	Package Description	Package Option	Ordering Quantity	Branding
		(mV)	(%)						
ADR06AR	3	6	0.2	10	-40°C to +125°C	8-Lead SOIC-N	R-8	98	
ADR06AR-REEL7	3	6	0.2	10	-40°C to +125°C	8-Lead SOIC-N	R-8	1,000	
ADR06ARZ ¹	3	6	0.2	10	-40°C to +125°C	8-Lead SOIC-N	R-8	98	
ADR06ARZ-REEL7 ¹	3	6	0.2	10	-40°C to +125°C	8-Lead SOIC-N	R-8	1,000	
ADR06BR	3	3	0.1	3	-40°C to +125°C	8-Lead SOIC-N	R-8	98	
ADR06BR-REEL7	3	3	0.1	3	-40°C to +125°C	8-Lead SOIC-N	R-8	1,000	
ADR06BRZ ¹	3	3	0.1	3	-40°C to +125°C	8-Lead SOIC-N	R-8	98	
ADR03BRZ-REEL7 ¹	3	3	0.1	3	-40°C to +125°C	8-Lead SOIC-N	R-8	1,000	
ADR06AUJ-REEL7	3	6	0.2	25	-40°C to +125°C	5-Lead TSOT	UJ-5	3,000	RWA
ADR06AUJ-R2	3	6	0.2	25	-40°C to +125°C	5-Lead TSOT	UJ-5	250	RWA
ADR06AUJZ-REEL7 ¹	3	6	0.2	25	-40°C to +125°C	5-Lead TSOT	UJ-5	3,000	R1L
ADR06BUJ-REEL7	3	3	0.1	9	-40°C to +125°C	5-Lead TSOT	UJ-5	3,000	RWB
ADR06BUJ-R2	3	3	0.1	9	-40°C to +125°C	5-Lead TSOT	UJ-5	250	RWB
ADR06BUJZ-REEL7 ¹	3	3	0.1	9	-40°C to +125°C	5-Lead TSOT	UJ-5	3,000	R1M
ADR06AKS-REEL7	3	6	0.2	25	-40°C to +125°C	5-Lead SC70	KS-5	3,000	RWA
ADR06AKS-R2	3	6	0.2	25	-40°C to +125°C	5-Lead SC70	KS-5	250	RWA
ADR06AKSZ-REEL7 ¹	3	6	0.2	25	-40°C to +125°C	5-Lead SC70	KS-5	3,000	R1L
ADR06BKS-REEL7	3	3	0.1	9	-40°C to +125°C	5-Lead SC70	KS-5	3,000	RWB
ADR06BKS-R2	3	3	0.1	9	-40°C to +125°C	5-Lead SC70	KS-5	250	RWB
ADR06BKSZ-REEL7 ¹	3	3	0.1	9	-40°C to +125°C	5-Lead SC70	KS-5	3,000	R1M
ADR06CRZ ¹	3	6	0.2	40	-40°C to +125°C	8-Lead SOIC-N	R-8	98	
ADR06CRZ-REEL ¹	3	6	0.2	40	-40°C to +125°C	8-Lead SOIC-N	R-8	2,500	

¹ Z = RoHS Compliant Part.

NOTES

NOTES