

SPRING & BUTTON CONTACTS

For "AAA" · "AAAA" · "N" · "12V"

- Economical and reliable contacts are ideal for molded cases with self contained battery compartments
- Single and dual contact designs available for "AAA", "AAAA", "N" & "12V" size batteries
- "Solder tab" design for either wire lead or PC mounting
- Unique spring contacts adjust to variations in battery lengths
- Reliable spring contacts assure low contact resistance and a dependable connection
- Space saving, economical, excellent mechanical construction

MATERIAL:

Plate: .020 (.51) thick Steel, Nickel Plate **Spring:** Spring Steel, Nickel Plate



Refer to page 27 for Battery Contact Layout & Mounting Details

For "AAA" · "AAAA" · "N" · "12V"

(+) POSITIVE BUTTON WITH TAB

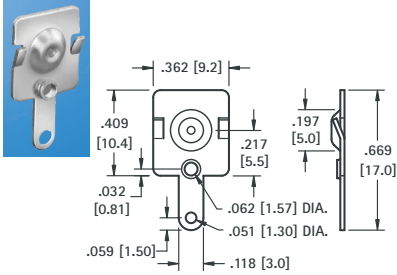

CAT. NO. 5226

(+) POSITIVE BUTTON

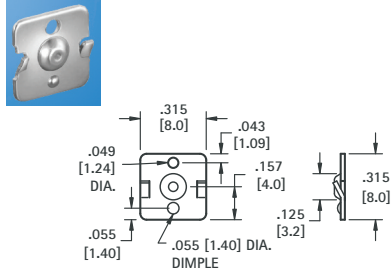

CAT. NO. 5225

DUAL CONTACT (RIGHT)

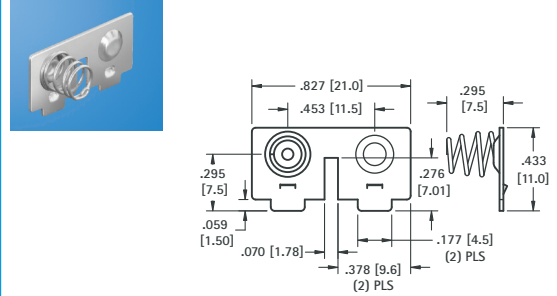

CAT. NO. 5213

(-) NEGATIVE SPRING WITH TAB

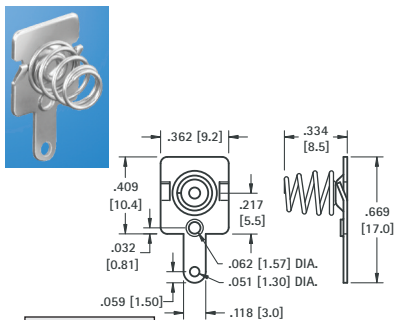

CAT. NO. 5204

(-) NEGATIVE SPRING

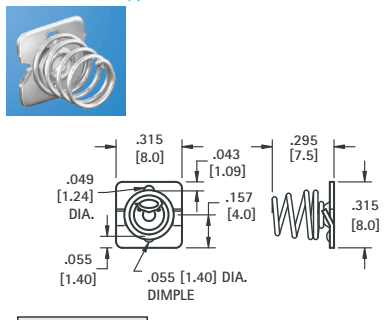

CAT. NO. 5203

DUAL CONTACT (LEFT)

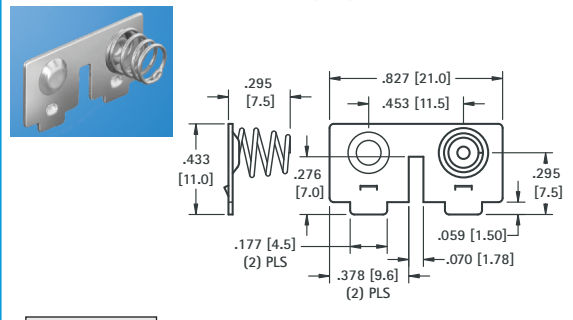

CAT. NO. 5214

LEAF-SPRING CONTACTS

For "A" · "AA" · "9V"

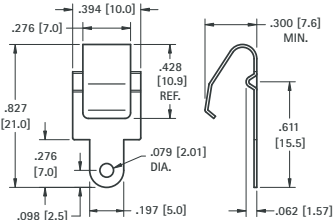

CAT. NO. 5209

MATERIAL: .012 (.30) thick Phosphor Bronze, Nickel Plate

Refer to page 27 for Battery Contact Layout & Mounting Details

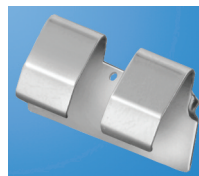

CAT. NO. 5208

MATERIAL: .012 (.30) thick Phosphor Bronze, Nickel Plate

For "A" · "AA"

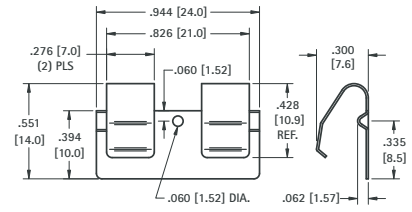

CAT. NO. 230-1

UNIVERSAL BATTERY SIZES

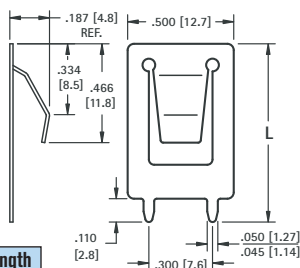

CAT. NO.	(L) Length
109-2	.840 (21.3)
109-3	1.000 (25.4)

MATERIAL: .012 (.30) thick Spring Steel, Nickel Plate

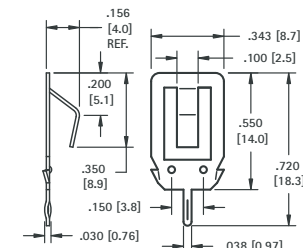

CAT. NO. 108-2

MATERIAL: .012 (.30) thick Spring Steel, Tin Nickel Plate



For "AAA" · "AAAA" · "N" · "12V"

- Designed for remote control applications

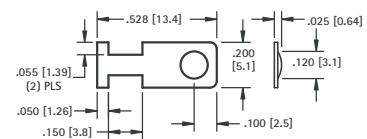

CAT. NO. 230-1

MATERIAL: .008 (.20) thick Spring Steel, Tin Nickel Plate



Semic Trade, s.r.o., Volutová 2521/18, 158 00 Praha 5
 Telephone: +420 251 625 331, 251 625 332, 251 625 377
 GSM: +420 605 999 994 Fax: +420 251 626 252, 251 626 393



www.semic.cz
 semic@semic.cz

BATTERY CONTACTS FOR MOLDED CASES