

B40FS ... B500FS

Fast switching Surface Mount Si-Bridge-Rectifiers Schnelle Si-Brückengleichrichter für die Oberflächenmontage

Version 2006-12-09

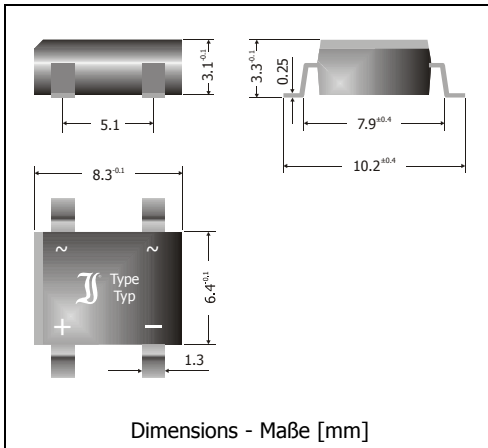

Nominal current Nennstrom	1 A
Alternating input voltage Eingangswchelspannung	40...380 V
Plastic case SO-DIL Kunststoffgehäuse SO-DIL	8.3 x 6.4 x 3.1 [mm]
Weight approx. – Gewicht ca.	0.4 g
Plastic material has UL classification 94V-0 Gehäusematerial UL94V-0 klassifiziert	
Standard packaging taped and reeled Standard Lieferform gegurtet auf Rolle	



Recognized Product – Underwriters Laboratories Inc.® File E175067
Anerkanntes Produkt – Underwriters Laboratories Inc.® Nr. E175067

Maximum ratings

Grenzwerte

Type Typ	Max. alternating input voltage Max. Eingangswchelspannung V_{VRMS} [V]	Repetitive peak reverse voltage Periodische Spitzensperrensannung V_{RRM} [V] ¹⁾
B40FS	40	80
B80FS	80	160
B125FS	125	250
B250FS	250	600
B380FS	380	800

Repetitive peak forward current Periodischer Spitzenstrom	$f > 15$ Hz	I_{FRM}	10 A ²⁾
Peak forward surge current, 50/60 Hz half sine-wave Stoßstrom für eine 50/60 Hz Sinus-Halbwelle	$T_A = 25^\circ\text{C}$	I_{FSM}	40/44 A
Rating for fusing, $t < 10$ ms Grenzlastintegral, $t < 10$ ms	$T_A = 25^\circ\text{C}$	i^2t	8 A ² s
Operating junction temperature – Sperrschichttemperatur		T_j	-50...+150°C
Storage temperature – Lagerungstemperatur		T_s	-50...+150°C

1 Valid per diode – Gültig pro Diode

2 Max. temperature of the terminals $T_T = 100^\circ\text{C}$ – Max. Temperatur der Anschlüsse $T_T = 100^\circ\text{C}$

Characteristics
Kenwerte

Max. average forward rectified current Dauergrenzstrom	$T_A = 50^\circ\text{C}$	R-load C-load	I_{FAV} I_{FAV}	$1.0\text{ A}^1)$ $0.8\text{ A}^1)$
Forward voltage – Durchlass-Spannung	$T_j = 25^\circ\text{C}$	$I_F = 1\text{ A}$	V_F	$< 1.3\text{ V}^2)$
Leakage current – Sperrstrom	$T_j = 25^\circ\text{C}$	$V_R = V_{RRM}$	I_R	$< 10\ \mu\text{A}$
Reverse recovery time Sperrverzug	$I_F = 0.5\text{ A}$ through/über $I_R = 1\text{ A}$ to/auf $I_R = 0.25\text{ A}$		t_{rr}	$< 300\text{ ns}$
Thermal resistance junction to ambient air Wärmewiderstand Sperrschicht – umgebende Luft			R_{thA}	$< 60\text{ K/W}^1)$

Type Typ	Max. admissible load capacitor Max. zulässiger Ladekondensator C_L [μF]	Min. required protective resistor Min. erforderl. Schutzwiderstand R_t [Ω]
B40FS	2500	2.0
B80FS	1250	4.0
B125FS	800	6.3
B250FS	333	15.0
B380FS	250	20.0

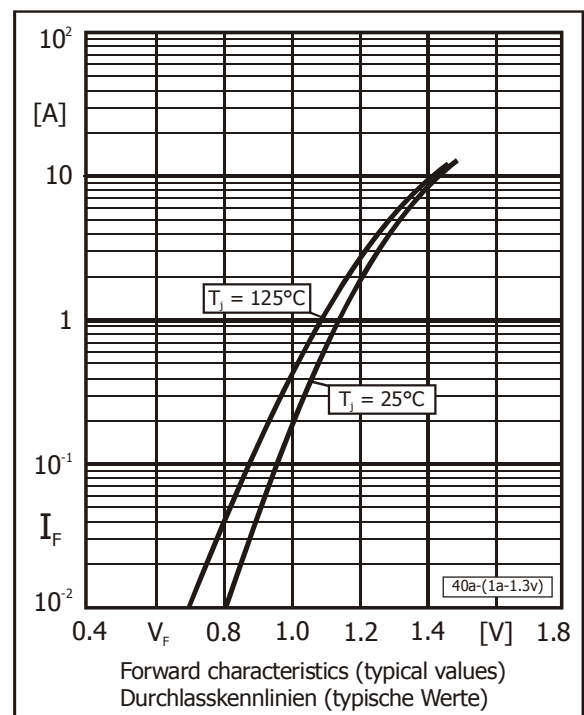
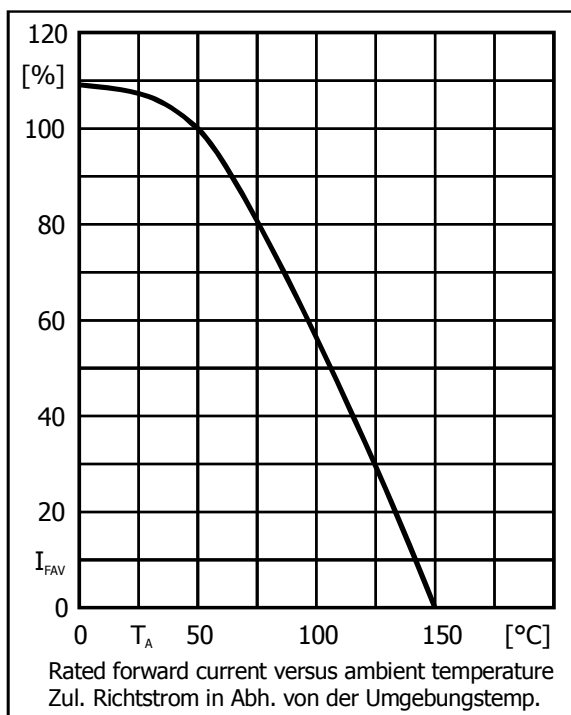

- 1 Mounted on P.C. Board with 25 mm² copper pads at each terminal
Montage auf Leiterplatte mit 25 mm² Kupferbelag (Löt-pad) an jedem Anschluss
- 2 Valid per diode – Gültig pro Diode