

# Optocoupler with Phototransistor Output

## Description

The CNY17 series consists of a phototransistor optically coupled to a gallium arsenide infrared-emitting diode in a 6-lead plastic dual in line package. The elements are mounted on one leadframe using a **coplanar technique**, providing a fixed distance between input and output for highest safety requirements.

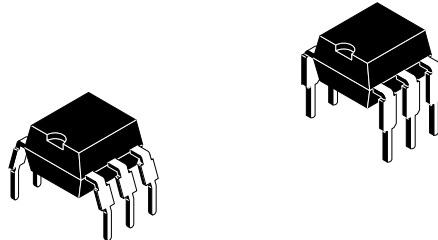

14827

## Applications

Circuits for safe protective separation against electrical shock according to safety class II (reinforced isolation):

- For appl. class I – IV at mains voltage  $\leq 300$  V
- For appl. class I – III at mains voltage  $\leq 600$  V according to VDE 0884, table 2, suitable for:

**Switch-mode power supplies, line receiver, computer peripheral interface, microprocessor system interface.**

## VDE Standards

These couplers perform safety functions according to the following equipment standards:

- **VDE 0884**  
Optocoupler for electrical safety requirements
- **IEC 950/EN 60950**  
Office machines (applied for reinforced isolation for mains voltage  $\leq 400$  V<sub>RMS</sub>)
- **VDE 0804**  
Telecommunication apparatus and data processing
- **IEC 65** Safety for mains-operated electronic and related household apparatus

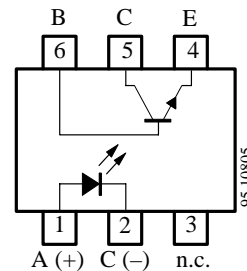

**0884**

## Order Instruction

Ordering Code	CTR Ranking	Remarks
CNY17-1/ CNY17G-1 <sup>1)</sup>	40 to 80%	
CNY17-2/ CNY17G-2 <sup>1)</sup>	63 to 125%	
CNY17-3/ CNY17G-3 <sup>1)</sup>	100 to 200%	
CNY17-4/ CNY17G-4 <sup>1)</sup>	160 to 320%	
<sup>1)</sup> G = Leadform 10.16 mm; G is not market on the body		



## Features

### Approvals:

- **BSI:** BS EN 41003, BS EN 60095 (BS 415), BS EN 60950 (BS 7002), Certificate number 7081 and 7402
- **FIMKO (SETI):** EN 60950, Certificate number 12399
- **Underwriters Laboratory (UL)** 1577 recognized, file number E-76222
- **VDE 0884,** Certificate number 94778

### VDE 0884 related features:

- Rated impulse voltage (transient overvoltage)  $V_{IOTM} = 6$  kV peak
- Isolation test voltage (partial discharge test voltage)  $V_{pd} = 1.6$  kV
- Rated isolation voltage (RMS includes DC)  $V_{IOWM} = 600 V_{RMS}$  (848 V peak)

- Rated recurring peak voltage (repetitive)  $V_{IORM} = 600 V_{RMS}$
- Creepage current resistance according to VDE 0303/IEC 112  
Comparative Tracking Index: **CTI = 275**
- Thickness through insulation  $\geq 0.75$  mm

### General features:

- Isolation materials according to UL94-VO
- Pollution degree 2 (DIN/VDE 0110 part 1 resp. IEC 664)
- Climatic classification 55/100/21 (IEC 68 part 1)
- Special construction: Therefore, extra low coupling capacity of typical 0.3 pF, high **Common Mode Rejection**
- CTR offered in 4 groups
- Low temperature coefficient of CTR
- Coupling System A

## Input (Emitter)

Parameter	Test Conditions	Symbol	Value	Unit
Reverse voltage		$V_R$	5	V
Forward current		$I_F$	60	mA
Forward surge current	$t_p \leq 10 \mu s$	$I_{FSM}$	3	A
Power dissipation	$T_{amb} \leq 25^\circ C$	$P_V$	100	mW
Junction temperature		$T_j$	125	$^\circ C$

## Output (Detector)

Parameter	Test Conditions	Symbol	Value	Unit
Collector emitter voltage		$V_{CEO}$	32	V
Emitter collector voltage		$V_{ECO}$	7	V
Collector current		$I_C$	50	mA
Collector peak current	$t_p/T = 0.5, t_p \leq 10$ ms	$I_{CM}$	100	mA
Power dissipation	$T_{amb} \leq 25^\circ C$	$P_V$	150	mW
Junction temperature		$T_j$	125	$^\circ C$

## Coupler

Parameter	Test Conditions	Symbol	Value	Unit
Isolation test voltage (RMS)		$V_{IO}$	3.75	kV
Total power dissipation	$T_{amb} \leq 25^\circ C$	$P_{tot}$	250	mW
Ambient temperature range		$T_{amb}$	-55 to +100	$^\circ C$
Storage temperature range		$T_{stg}$	-55 to +125	$^\circ C$
Soldering temperature	2 mm from case, $t \leq 10$ s	$T_{sd}$	260	$^\circ C$



### Electrical Characteristics ( $T_{amb} = 25^{\circ}\text{C}$ )

#### Input (Emitter)

Parameter	Test Conditions	Symbol	Min.	Typ.	Max.	Unit
Forward voltage	$I_F = 50 \text{ mA}$	$V_F$		1.25	1.6	V
Junction capacitance	$V_R = 0, f = 1 \text{ MHz}$	$C_j$		50		pF

#### Output (Detector)

Parameter	Test Conditions	Symbol	Min.	Typ.	Max.	Unit
Collector emitter voltage	$I_C = 1 \text{ mA}$	$V_{CEO}$	32			V
Emitter collector voltage	$I_E = 100 \mu\text{A}$	$V_{ECO}$	7			V
Collector emitter cut-off current	$V_{CE} = 10 \text{ V}, I_f = 0$	$I_{CEO}$		10	100	nA

#### Coupler

Parameter	Test Conditions	Symbol	Min.	Typ.	Max.	Unit
AC isolation test voltage (RMS)	$f = 50 \text{ Hz}, t = 1 \text{ s}$	$V_{IO}$	3.75			V
Collector emitter saturation voltage	$I_F = 10 \text{ mA}, I_C = 1 \text{ mA}$	$V_{CEsat}$			0.3	V
Cut-off frequency	$V_{CE} = 5 \text{ V}, I_F = 10 \text{ mA}, R_L = 100 \Omega$	$f_c$		110		kHz
Coupling capacitance	$f = 1 \text{ MHz}$	$c_k$		0.3		pF

#### Current Transfer Ratio (CTR)

Parameter	Test Conditions	Type	Symbol	Min.	Typ.	Max.	Unit
$I_C/I_F$	$V_{CE} = 5 \text{ V}, I_F = 10 \text{ mA}$	CNY17(G)-1	CTR	0.4		0.8	
		CNY17(G)-2	CTR	0.63		1.25	
		CNY17(G)-3	CTR	1.0		2.0	
		CNY17(G)-4	CTR	1.6		3.2	
	$V_{CE} = 5 \text{ V}, I_F = 1 \text{ mA}$	CNY17(G)-1	CTR	0.13			
		CNY17(G)-2	CTR	0.22			
		CNY17(G)-3	CTR	0.34			
		CNY17(G)-4	CTR	0.56			

## Maximum Safety Ratings (according to VDE 0884) see figure 1

This device is used for protective separation against electrical shock only within the maximum safety ratings. This must be ensured by using protective circuits in the applications.

### Input (Emitter)

Parameters	Test Conditions	Symbol	Value	Unit
Forward current		$I_{si}$	130	mA

### Output (Detector)

Parameters	Test Conditions	Symbol	Value	Unit
Power dissipation	$T_{amb} \leq 25^\circ\text{C}$	$P_{si}$	265	mW

### Coupler

Parameters	Test Conditions	Symbol	Value	Unit
Rated impulse voltage		$V_{IOTM}$	6	kV
Safety temperature		$T_{si}$	150	$^\circ\text{C}$

## Insulation Rated Parameters (according to VDE 0884)

Parameter	Test Conditions	Symbol	Min.	Typ.	Max.	Unit
Partial discharge test voltage – Routine test	100%, $t_{test} = 1\text{ s}$	$V_{pd}$	1.6			kV
Partial discharge test voltage – Lot test (sample test)	$t_{Tr} = 60\text{ s}$ , $t_{test} = 10\text{ s}$ , (see figure 2)	$V_{IOTM}$	6			kV
		$V_{pd}$	1.3			kV
Insulation resistance	$V_{IO} = 500\text{ V}$	$R_{IO}$	$10^{12}$			$\Omega$
	$V_{IO} = 500\text{ V}$ , $T_{amb} = 100^\circ\text{C}$	$R_{IO}$	$10^{11}$			$\Omega$
	$V_{IO} = 500\text{ V}$ , $T_{amb} = 150^\circ\text{C}$ (construction test only)	$R_{IO}$	$10^9$			$\Omega$

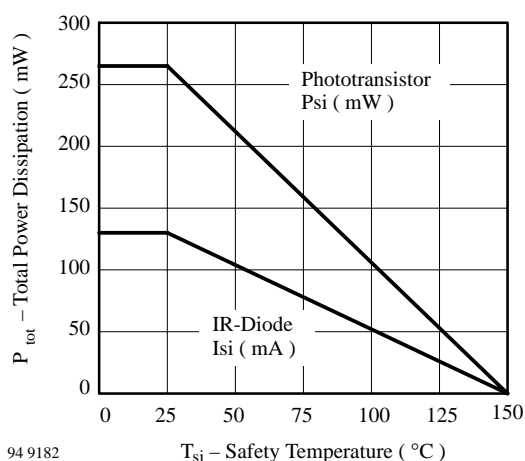

Figure 1. Derating diagram

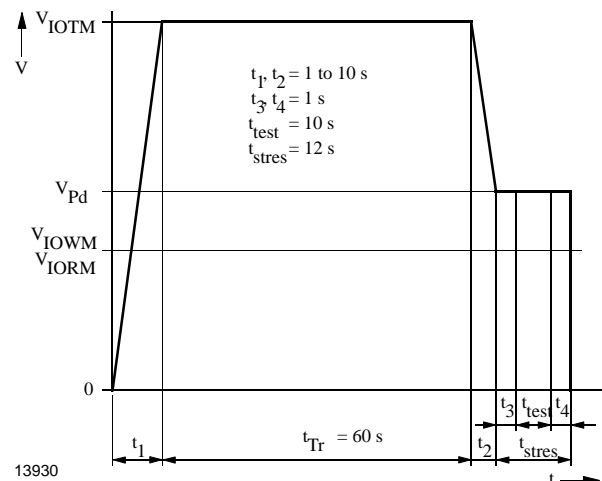

Figure 2. Test pulse diagram for sample test according to DIN VDE 0884

### Switching Characteristics

Parameter	Test Conditions	Symbol	Typ.	Unit
Delay time	$V_S = 5\text{ V}$ , $I_C = 5\text{ mA}$ , $R_L = 100\ \Omega$ (see figure 3)	$t_d$	4.0	$\mu\text{s}$
Rise time		$t_r$	7.0	$\mu\text{s}$
Fall time		$t_f$	6.7	$\mu\text{s}$
Storage time		$t_s$	0.3	$\mu\text{s}$
Turn-on time	$V_S = 5\text{ V}$ , $I_F = 10\text{ mA}$ , $R_L = 1\text{ k}\Omega$ (see figure 4)	$t_{on}$	11.0	$\mu\text{s}$
Turn-off time		$t_{off}$	7.0	$\mu\text{s}$
Turn-on time	$V_S = 5\text{ V}$ , $I_F = 10\text{ mA}$ , $R_L = 1\text{ k}\Omega$ (see figure 4)	$t_{on}$	25	$\mu\text{s}$
Turn-off time		$t_{off}$	42.5	$\mu\text{s}$

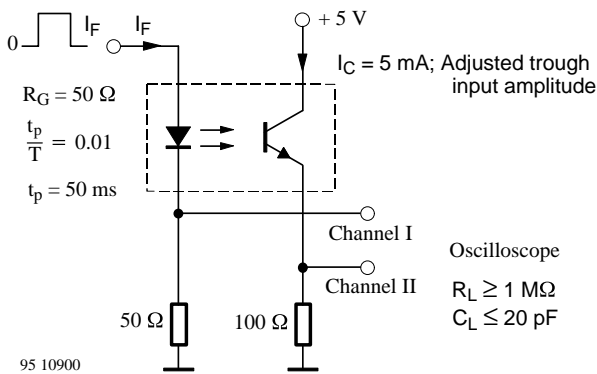

Figure 3. Test circuit, non-saturated operation

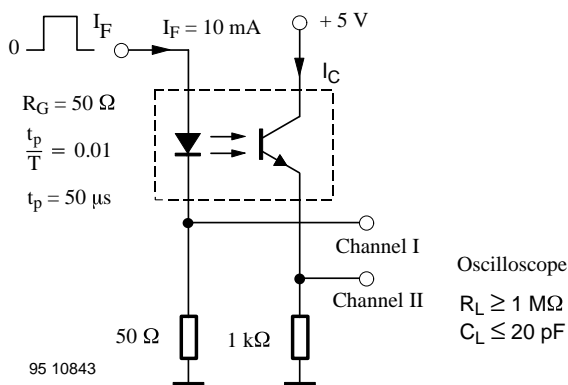

Figure 4. Test circuit, saturated operation

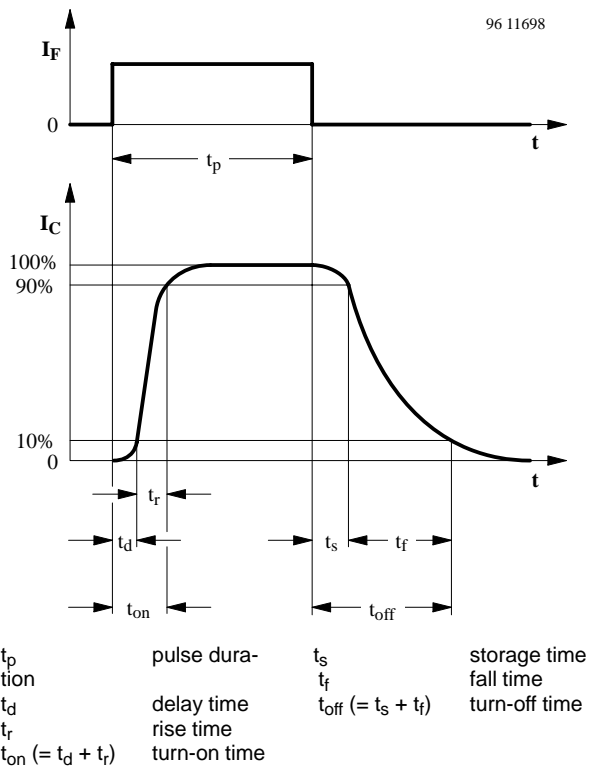

Figure 5. Switching times

## Typical Characteristics ( $T_{amb} = 25^{\circ}\text{C}$ , unless otherwise specified)

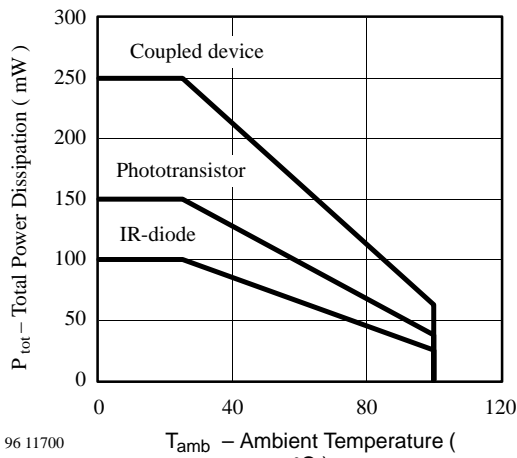

Figure 6. Total Power Dissipation vs. Ambient Temperature

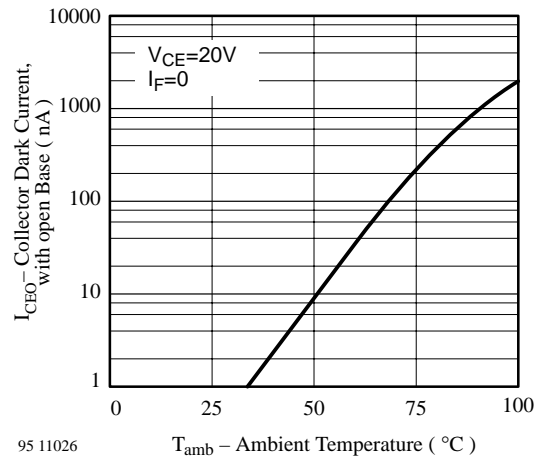

Figure 9. Collector Dark Current vs. Ambient Temperature

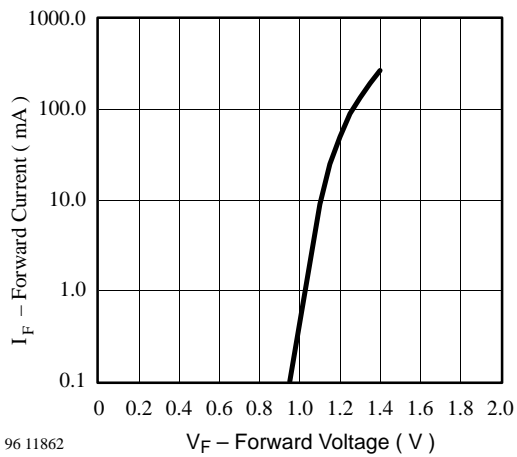

Figure 7. Forward Current vs. Forward Voltage

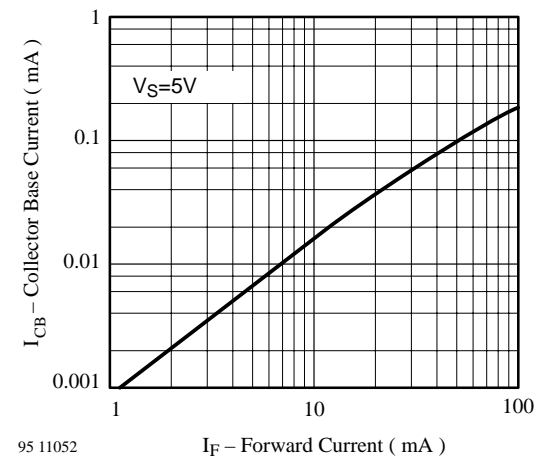

Figure 10. Collector Base Current vs. Forward Current

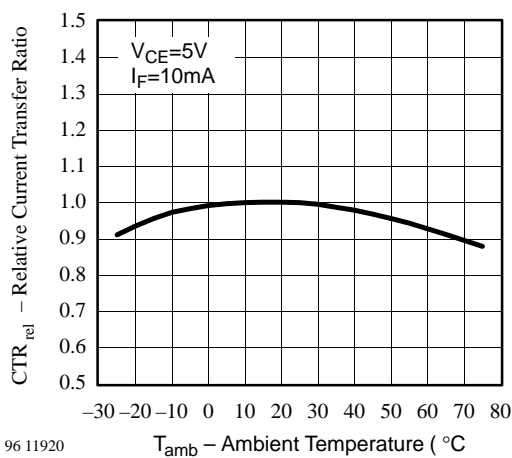

Figure 8. Relative Current Transfer Ratio vs. Ambient Temperature

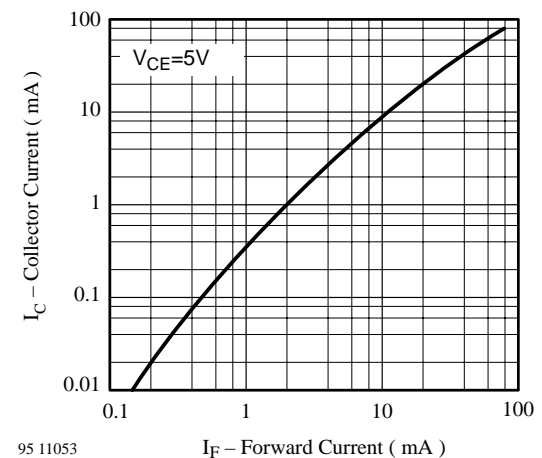

Figure 11. Collector Current vs. Forward Current

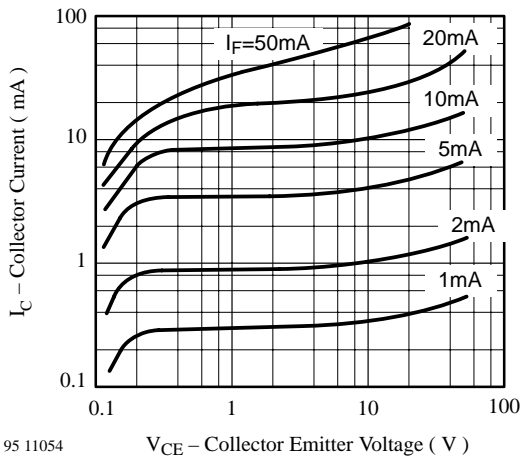

Figure 12. Collector Current vs. Collector Emitter Voltage

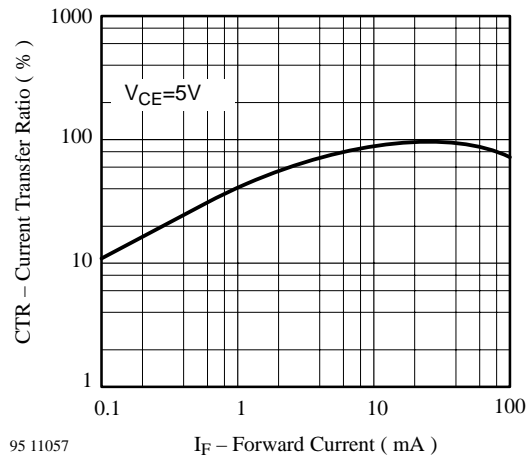

Figure 15. Current Transfer Ratio vs. Forward Current

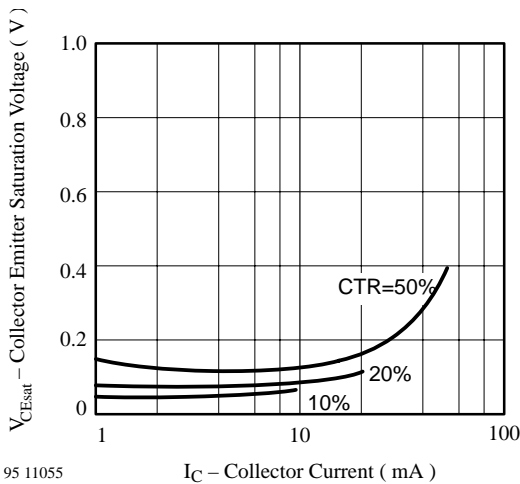

Figure 13. Collector Emitter Saturation Voltage vs. Collector Current

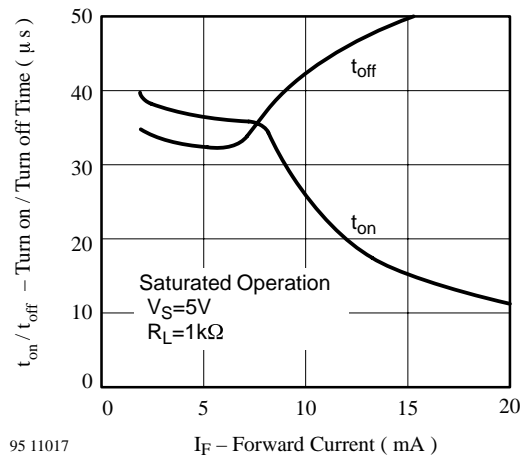

Figure 16. Turn on / off Time vs. Forward Current

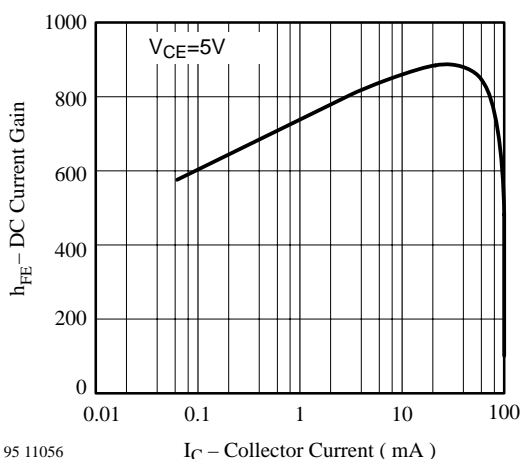

Figure 14. DC Current Gain vs. Collector Current

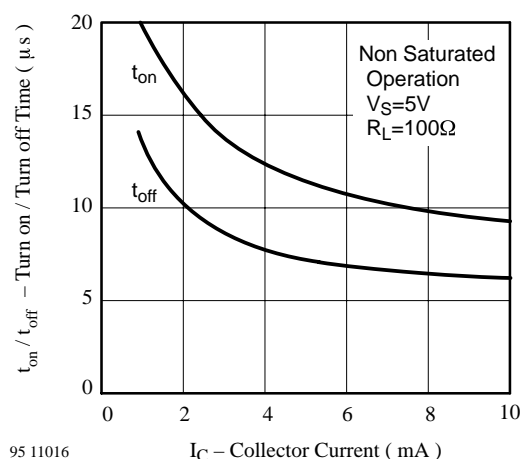

Figure 17. Turn on / off Time vs. Collector Current

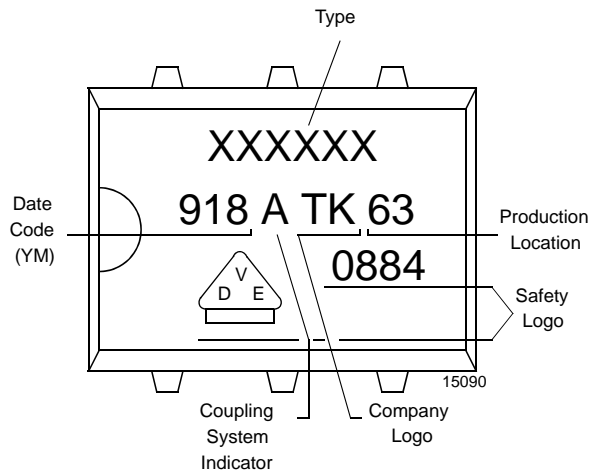
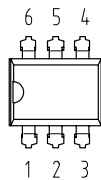
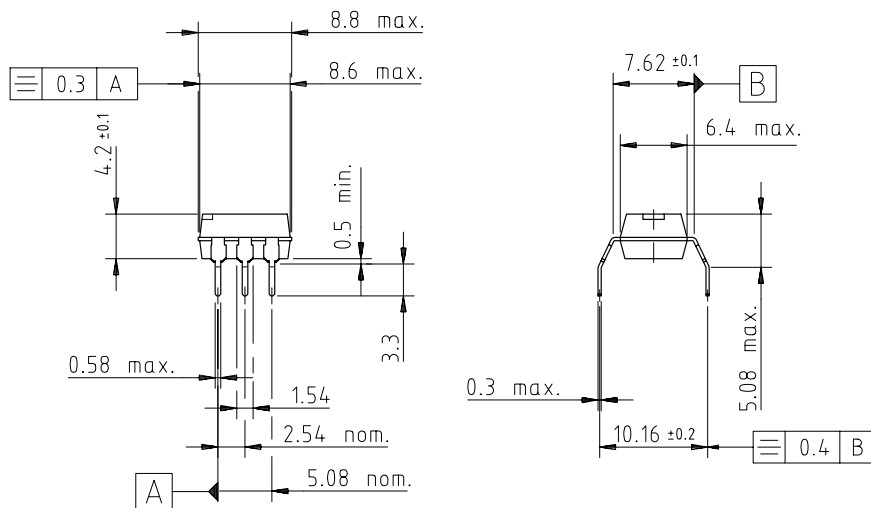

Figure 18. Marking example

## Dimensions of CNY17G in mm



weight: ca. 0.50 g  
 creepage distance:  $\approx$  8 mm  
 air path:  $\geq$  8 mm

after mounting on PC board

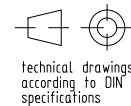

14771



# CNY17 Series

Vishay Telefunken



## Dimensions of CNY17 in mm

