

PMC - (Expanded range; new lugs)

Metallized polypropylene film capacitor

MKP - Switching - High current

Main applications

Switching capacitor for resonant circuits, industrial and motor speed controls, induction heaters, high frequency and high current applications

Dielectric

Polypropylene

Electrodes

Vacuum deposited metal layers

Coating

Solvent resistant plastic case with resin sealing (UL 94 V-0). Flame retardant execution

Construction

Extended metallized film (refer to general technical information)

Terminals

Tinned copper (brass) lugs (lead-free) for screw fixing (please refer to article table)

Degree of protection

IP00

Installation

Whatever position assuring correct heat dissipation. Arrangement of many components with box walls in contact not admitted; suggested minimum distance between side by side elements $\geq 1/8$ of the box thickness (B size). Box with lugs terminals must be free to correctly dissipate from all the body faces

Reference standard

IEC 61071, IEC 60068, RoHS compliant

Climatic category

40/85/56 (IEC 60068/1), GPD (DIN40040)

Operating temperature range (case)

-40...+85°C (+100°C observing voltage and current de-rating)

Max. permissible ambient temperature

+70°C, operation at rated power, current, voltage and natural cooling (+85°C observing voltage and current de-rating)

Rated capacitance (Cr)

1,2 μ F to 75 μ F. Refer to article table

Capacitance tolerance (at 1kHz)

$\pm 10\%$ (code=K), $\pm 5\%$ (code=J). Other tolerances upon request

Capacitance temperature coefficient

Refer to graphs in general technical information

Long term stability (at 1 kHz)

Capacitance variation $\leq \pm 1\%$ after a period of 2 years at standard environmental conditions

Rated voltage (Ur)

250, 330, 400, 600, 700 Vdc

Temperature de-rated voltage

For operating temperature (case) $> +85^\circ\text{C}$,
Ur must be decreased 1,5% for every $^\circ\text{C}$ exceeding $+85^\circ\text{C}$
Urms must be decreased 2,5% for every $^\circ\text{C}$ exceeding $+85^\circ\text{C}$

Non recurrent surge voltage (Upk)

400, 500, 600, 800, 1000 Vdc

Self inductance

$\leq 1\text{nH/mm}$ of fixing pitch

Maximum pulse rise time

Refer to article table

Maximum peak current (Ipeak)

Refer to article table. Max. non repetitive $I_{pk} = 1,5 \times I_{peak}$

Dissipation factor (DF), max.

$Tg\delta \times 10^{-4}$, measured at $25\pm 5^\circ\text{C}$, 1kHz

Cr $\leq 5\mu\text{F}$	$5\mu\text{F} < \text{Cr} \leq 25\mu\text{F}$	$25\mu\text{F} < \text{Cr} \leq 60\mu\text{F}$	Cr $> 60\mu\text{F}$
5	8	10	12

Insulation resistance (IR)

$\geq 30000\text{s}$ but need not exceed $30\text{G}\Omega$ (typical value), when measured between terminals, at $25\pm 5^\circ\text{C}$, after 1 minute of electrification at 100Vdc

Test voltage between terminals (Ut)

$1,6 \times U_r$ (DC) applied for 10s / $2 \times U_r$ (DC) applied for 2s, at $25\pm 5^\circ\text{C}$

Test voltage between terminals and case (Utc)

3kV 50+60Hz applied for 60s at $25\pm 5^\circ\text{C}$

Damp heat test (steady state)

Test conditions:

Temperature= $+40\pm 2^\circ\text{C}$

Relative humidity= $93\pm 2\%$

Test duration= 56 days

Performance:

Capacitance change $\leq \pm 2\%$

DF change ≤ 0.0010 at 1kHz

IR $\geq 50\%$ of initial limit value

Typical capacitance change versus operating time

-5% after 30'000 hours at Urms or after 100'000 hours at Ur

Life expectancy

$\geq 100'000$ hours (Ur); 30'000 hours (Urms)

Failure quota

300/10⁹ component hours

Warning: this specification must be completed with the data given in the "General technical information" chapter

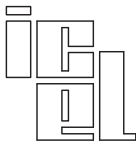

PMC - (Expanded range; new lugs)
Metallized polypropylene film capacitor
MKP - Switching - High current

Dimensions in mm (drawings not in scale)

Style **SP-SPM8 / SR-SRM8**

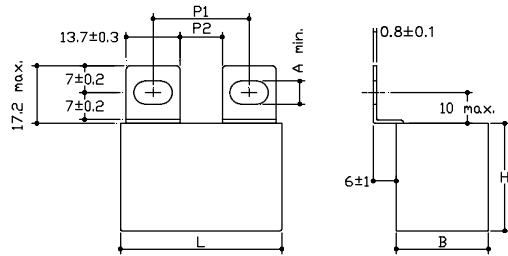

Style **VP-VPM8 / VR-VRM8**

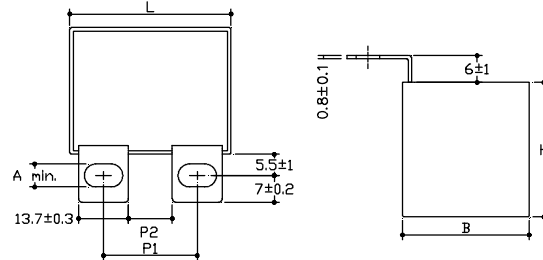

Style **FP-FPM8 / FR-FRM8**

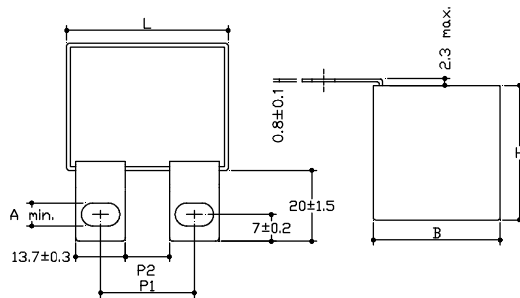

Fixing pitch and distance between lugs (mm)			
Lugs style	L	P1	P2
SP-SPM8	42+42,5	23+28(M6) 25+26(M8)	11min.
VP-VPM8	57,5	37+42(M6) 39+40(M8)	24min.
FP-FPM8			
SR-SRM8	42+42,5	20+25(M6) 22+23(M8)	8min.
VR-VRM8	57,5	34+39(M6) 36+37(M8)	21min.
FR-FRM8			

Fixing slot size (mm)**	
SP, VP, FP, SR, VR, FR	A= 6min.
SPM8, VPM8, FPM8, SRM8, VRM8, FRM8	A= 8min.

** Standard fixing slots for M6 screws,
 slots for M8 screws available upon request

Style **SN-SNM8** (for L=57,5mm only)

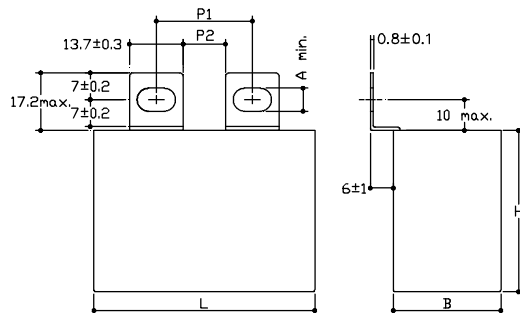

Style **VN-VNM8** (for L=57,5mm only)

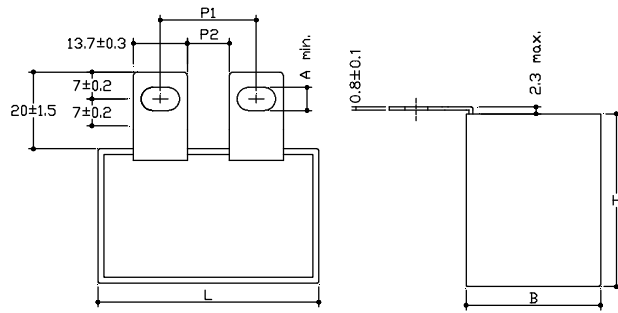

Fixing pitch and distance between lugs (mm)			
Lugs style	L	P1	P2
SN-SNM8	42+42,5	Not available	
VN-VNM8	57,5	23+28(M6) 25+26(M8)	11min.

Fixing slot size (mm)**	
SN, VN	A= 6min.
SNM8, VNM8	A= 8min.

** Standard fixing slots for M6 screws,
 slots for M8 screws available upon request

Style **AP**

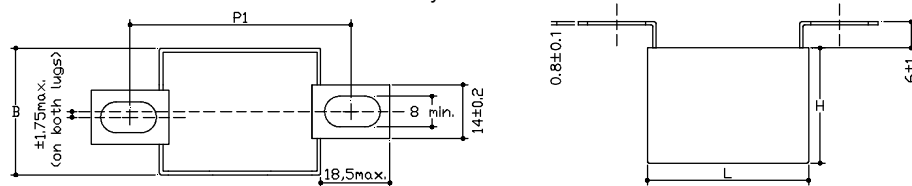

Fixing pitch and distance between lugs (mm)			
Lugs style	L	P1	P2
AP	42+42,5	53,5+63 (M8)	-
	57,5	68,5+77 (M8)	-

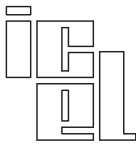

PMC - (Expanded range; new lugs)
Metallized polypropylene film capacitor
MKP - Switching - High current

Dimensions in mm (drawings not in scale)

Style **BP** (Not available for L=57,5mm)

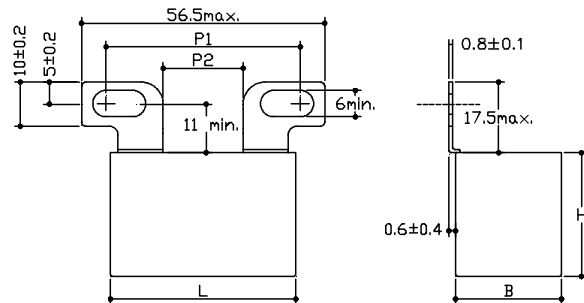

Fixing pitch and distance between lugs (mm)			
Lugs style	L	P1	P2
BP	42÷42,5	32÷45 (M6)	17min.
	57,5	Not available	

Style **SL** (M8 slots only)

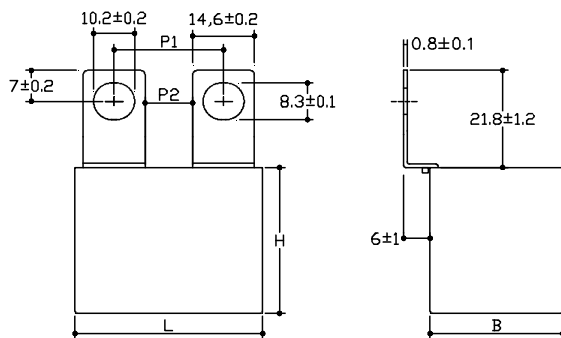

Fixing pitch and distance between lugs (mm)			
Lugs style	L	P1	P2
SL	42÷42,5	22÷24 (M8)	8min.
	57,5	36÷38 (M8)	21min.

Style **BN** (M6 slots only; not available for L=57,5mm and for L=42÷42,5mm having B>22mm)

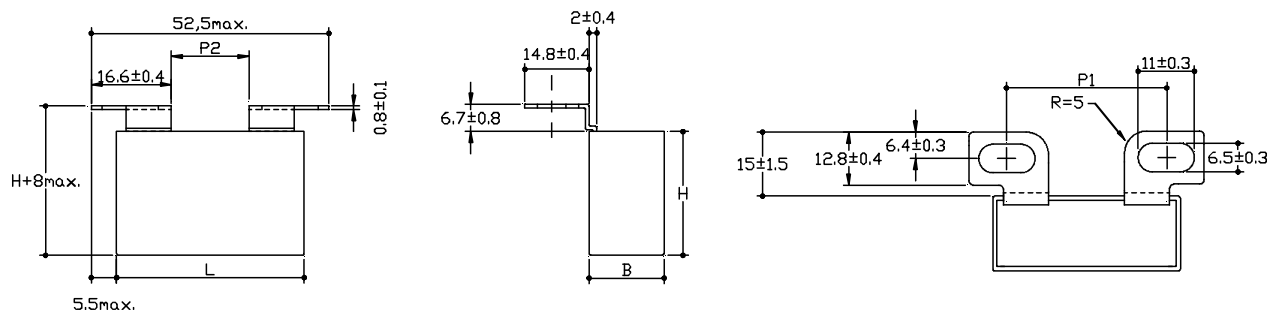

Fixing pitch and distance between lugs (mm)			
Lugs style	L	P1	P2
BN	42÷42,5	30÷37 (M6)	15min.
		Not available for B>22	
	57,5	Not available	

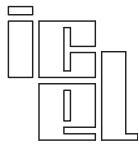

PMC - (Expanded range; new lugs)

Metallized polypropylene film capacitor

MKP - Switching - High current

PMC article table (different values available upon request) - (^)= NOT FOR NEW DESIGN: replaced with 30x45x42.5mm box

Ur Vdc	Urms Vac ⁽⁴⁾	UpK Vdc	Cap. µF	Dimension in mm			du/dt V/µs	Ipeak A	Irms ⁽²⁾ A	ESR ⁽³⁾ mΩ	ICEL Code ⁽¹⁾
				B	H	L					
250	160	400	10	17	28	42,5	25	250	18	2,7	PMC1255100*##B
250	160	400	10	24,5	27,5	42,5	25	250	18	2,7	PMC1255100*##
250	160	400	15	22	33,5	42,5	25	375	22	2,3	PMC1255150*##B
250	160	400	15	33,5	35,5	42,5	25	375	23,5	2,3	PMC1255150*##
250	160	400	20	33,5	35,5	42,5	25	500	27	2	PMC1255200*##
250	160	400	22	33,5	35,5	42,5	25	550	27,5	2	PMC1255220*##
250	160	400	22	28	37	42,5	25	550	27,5	2	PMC1255220*##A
250	160	400	25	33,5	35,5	42,5	25	625	28,5	1,9	PMC1255250*##
250	160	400	30	30	45	42,5	25	750	30	1,8	PMC1255300*##A
250	160	400	30	33	45	42,5	25	750	30	1,8	PMC1255300*## (^)
250	160	400	33	33	45	42,5	25	825	31,5	1,8	PMC1255330*##
250	160	400	35	33	45	42,5	25	875	32	1,7	PMC1255350*##
250	160	400	40	30	45	57,5	15	600	28,5	2,5	PMC1255400*##
250	160	400	50	35	50	57,5	15	750	32,5	2,2	PMC1255500*##
250	160	400	60	35	50	57,5	15	900	34,5	2	PMC1255600*##
250	160	400	68	38	57,5	57,5	15	1020	36,5	1,9	PMC1255680*##
250	160	400	75	38	57,5	57,5	15	1125	37,5	1,8	PMC1255750*##
330	220	500	4,7	17	28	42,5	30	141	15	3,8	PMC1334470*##
330	220	500	6,8	17	32	42	30	204	18	2,9	PMC1334680*##A
330	220	500	6,8	24,5	27,5	42,5	30	204	18	2,9	PMC1334680*##
330	220	500	10	22	33,5	42,5	30	300	21	2,5	PMC1335100*##
330	220	500	15	33,5	35,5	42,5	30	450	26,5	2,1	PMC1335150*##
330	220	500	15	28	37	42,5	30	450	26,5	2,1	PMC1335150*##A
330	220	500	20	33	45	42,5	30	600	30,5	1,9	PMC1335200*##
330	220	500	22	33	45	42,5	30	660	32	1,8	PMC1335220*##
330	220	500	25	30	45	57,5	17	425	26	2,9	PMC1335250*##
330	220	500	30	30	45	57,5	17	510	28	2,7	PMC1335300*##
330	220	500	35	35	50	57,5	17	595	30,5	2,4	PMC1335350*##
330	220	500	40	35	50	57,5	17	680	32,5	2,2	PMC1335400*##
330	220	500	47	38	57,5	57,5	17	799	34	2,1	PMC1335470*##
330	220	500	55	38	57,5	57,5	17	850	35,5	2	PMC1335550*##
400	275	600	4	17	28	42,5	40	160	16,5	3,4	PMC1404400*##B
400	275	600	4	24,5	27,5	42,5	40	160	16,5	3,4	PMC1404400*##
400	275	600	5	24,5	27,5	42,5	40	200	18,5	2,9	PMC1404500*##
400	275	600	6,8	22	33,5	42,5	40	272	22	2,5	PMC1404680*##B
400	275	600	6,8	33,5	35,5	42,5	40	272	23	2,5	PMC1404680*##
400	275	600	10	33,5	35,5	42,5	40	400	26,5	2,1	PMC1405100*##
400	275	600	10	28	37	42,5	40	400	26,5	2,1	PMC1405100*##A
400	275	600	12,5	30	45	42,5	40	500	29,5	2	PMC1405125*##A
400	275	600	12,5	33	45	42,5	40	500	29,5	2	PMC1405125*## (^)
400	275	600	15	33	45	42,5	40	600	31,5	1,9	PMC1405150*##
400	275	600	20	30	45	57,5	20	400	26,5	2,9	PMC1405200*##
400	275	600	22	35	50	57,5	20	440	28,5	2,8	PMC1405220*##
400	275	600	25	35	50	57,5	20	500	30,5	2,6	PMC1405250*##
400	275	600	30	38	57,5	57,5	20	600	33	2,3	PMC1405300*##
400	275	600	35	38	57,5	57,5	20	600	34,5	2,2	PMC1405350*##
600	350	800	2,2	17	28	42,5	55	121	14	4,3	PMC1604220*##
600	350	800	2,5	17	32	42	55	137,5	16	4	PMC1604250*##A
600	350	800	2,5	24,5	27,5	42,5	55	137,5	16	4	PMC1604250*##
600	350	800	3	24,5	27,5	42,5	55	165	17	3,6	PMC1604300*##
600	350	800	3,3	22	30	42,5	55	181,5	17,5	3,5	PMC1604330*##A
600	350	800	3,3	24,5	27,5	42,5	55	181,5	17	3,5	PMC1604330*##
600	350	600	4	22	33,5	42,5	55	220	20,5	2,8	PMC1604400*##B
600	350	800	4	33,5	35,5	42,5	55	220	21,5	2,8	PMC1604400*##
600	350	800	4,7	33,5	35,5	42,5	55	258,5	24	2,5	PMC1604470*##
600	350	800	5	33,5	35,5	42,5	55	275	24	2,5	PMC1604500*##
600	350	800	5	28	37	42,5	55	275	24	2,5	PMC1604500*##A
600	350	800	5,6	28	37	42,5	55	308	25	2,4	PMC1604560*##
600	350	800	6,8	30	45	42,5	55	374	28,5	2,2	PMC1604680*##A
600	350	800	6,8	33	45	42,5	55	374	28,5	2,2	PMC1604680*## (^)
600	350	800	9	33	45	42,5	55	495	31,5	1,9	PMC1604900*##
600	350	800	10	30	45	57,5	30	300	23,5	3,5	PMC1605100*##
600	350	800	12,5	35	50	57,5	30	375	26	3,2	PMC1605125*##
600	350	800	15	35	50	57,5	30	450	28,5	2,9	PMC1605150*##
600	350	800	20	38	57,5	57,5	30	600	32,5	2,5	PMC1605200*##

(1)Change the * symbol with the needed capacitance tolerance code: J=±5%, K=±10%, M=±20% and the ## characters with the needed style code - (2)Max. at 100kHz, +70°C for case operating T= +85°C (at T amb. >+70°C and T case>+85°C voltage and current de-rating must be observed), C tol. ±10% (for wider C tolerances, ESR variation must be taken in consideration) - (3)Typical values at 100kHz (for operating frequencies far from the reference, ESR variation and related power dissipation variation must be taken in consideration)- (4)Not suitable for across the line application

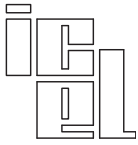
**PMC - (Expanded range; new lugs)**
Metallized polypropylene film capacitor
MKP - Switching - High current

Ur Vdc	Urms Vac ⁽⁴⁾	UpK Vdc	Cap. μF	Dimension in mm			du/dt V/μs	Ipeak A	Irms ⁽²⁾ A	ESR ⁽³⁾ mΩ	ICEL Code ⁽¹⁾
				B	H	L					
700	400	1000	1,2	17	28	42,5	70	84	12	5,6	PMC1704100*##
700	400	1000	1,5	17	32	42	70	105	14,5	4,8	PMC1704150*##A
700	400	1000	1,5	24,5	27,5	42,5	70	105	14,5	4,8	PMC1704150*##
700	400	1000	2	22	30	42,5	70	140	16,5	4	PMC1704200*##A
700	400	1000	2	24,5	27,5	42,5	70	140	16,5	4	PMC1704200*##
700	400	1000	2,5	22	33,5	42,5	70	175	18,5	3,4	PMC1704250*##
700	400	1000	2,5	33,5	35,5	42,5	70	175	19,5	3,4	PMC1704250*##
700	400	1000	3	33,5	35,5	42,5	70	210	21,5	3,1	PMC1704300*##
700	400	1000	3	28	37	42,5	70	210	21,5	3,1	PMC1704300*##A
700	400	1000	3,3	33,5	35,5	42,5	70	231	22,5	3	PMC1704330*##
700	400	1000	3,3	28	37	42,5	70	231	22,5	3	PMC1704330*##A
700	400	1000	4	30	45	42,5	70	280	26	2,6	PMC1704400*##A
700	400	1000	4	33	45	42,5	70	280	26	2,6	PMC1704400*## (^^)
700	400	1000	4,7	33	45	42,5	70	329	28,5	2,3	PMC1704470*##
700	400	1000	5	33	45	42,5	70	350	29	2,3	PMC1704500*##
700	400	1000	6,8	30	45	57,5	40	272	22,5	3,8	PMC1704680*##
700	400	1000	8	35	50	57,5	40	320	25,5	3,5	PMC1704800*##
700	400	1000	9	35	50	57,5	40	360	27	3,2	PMC1704900*##
700	400	1000	10	38	57,5	57,5	40	400	28,5	3,1	PMC1705100*##
700	400	1000	12	38	57,5	57,5	40	480	31,5	2,7	PMC1705120*##

⁽¹⁾Change the * symbol with the needed capacitance tolerance code: J=±5%, K=±10%, M=±20% and the ## characters with the needed style code - ⁽²⁾Max. at 100kHz, +70°C for case operating T= +85°C (at T amb. >+70°C and T case>+85°C voltage and current de-rating must be observed), C tol. ≤±10% (for wider C tolerances, ESR variation must be taken in consideration) - ⁽³⁾Typical values at 100kHz (for operating frequencies far from the reference, ESR variation and related power dissipation variation must be taken in consideration) - ⁽⁴⁾Not suitable for across the line application