



N-Channel Enhancement Mode MOSFET

Features

- ◆ $V_{DS} = 100V$
- ◆ $R_{DS(ON)} < 1.1 m\Omega @ V_{GS} = 10 V$
- ◆ Fully Avalanche Rated
- ◆ Pb Free & RoHS Compliant
- ◆ Isolation Type Package
- ◆ Electrically Isolation base plate

Preliminary

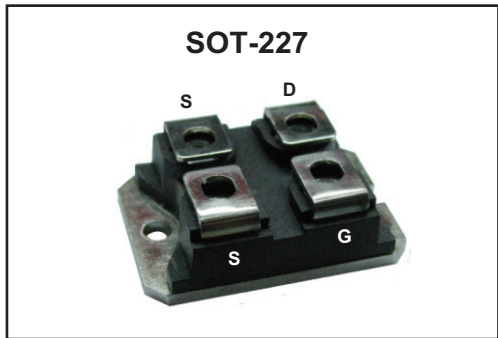
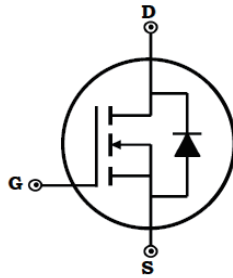

Dimensions in inches and (millimeters)

Applications

- ◆ Backlighting
- ◆ Power Converters
- ◆ Synchronous Rectifiers

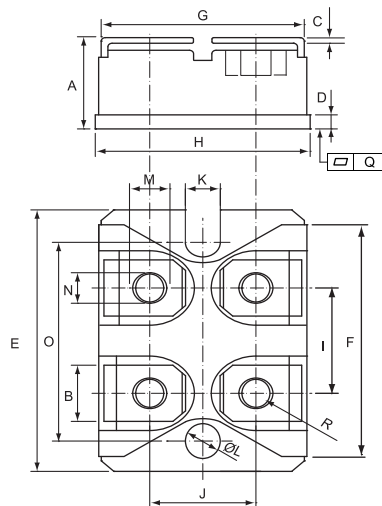

Absolute Maximum Ratings (Tc=25°C unless otherwise noted)

Parameter	Symbol	Ratings	Unit
Drain-Source Voltage	V_{DS}	100	V
Gate-Source Voltage	V_{GS}	±20	V
Drain Current-Continuous @ $T_c = 25^\circ C$ @ $T_c = 100^\circ C$	I_D	560 445	A
Drain Current-Pulsed @ $T_c = 25^\circ C$	I_{DM}	1600	A
Maximum Power Dissipation	P_D	890	W
Storage Temperature Range	T_{STG}	-50 to +150	°C
Operating Junction Temperature Range	T_J	-50 to +150	°C
Thermal Resistance, Junction-to-Case	$R_{\theta JC}$	0.10	°C/W
Isolation Voltage (A.C. 1 minute)	V_{iso}	2500	V
Mounting torque (M4 Screw)	To heatsink To terminal	1.5 1.3	Nm

	DIMENSIONS			
	INCHES		MM	
	MIN	MAX	MIN	MAX
A	0.460	0.483	11.68	12.28
B	0.307	0.323	7.80	8.20
C	0.030	0.033	0.75	0.85
D	0.071	0.081	1.80	2.05
E	1.488	1.504	37.80	38.20
F	1.248	1.260	31.70	32.00
G	0.917	0.957	23.30	24.30
H	0.996	1.008	25.30	25.60
I	0.579	0.602	14.70	15.30
J	0.492	0.516	12.50	13.10
K	0.161	0.169	4.10	4.30
L	0.161	0.169	4.10	4.30
M	0.181	0.197	4.60	5.00
N	0.165	0.181	4.20	4.60
O	1.181	1.197	30.00	30.40
Q	-0.002	0.004	-0.05	0.10
R	M4*8			



Electrical Characteristics @ T_J = 25°C (unless otherwise specified)

Parameter	Symbol	Conditions	Min.	Typ.	Max.	Unit
OFF Characteristics						
Drain-Source Breakdown Voltage	BV _{DSS}	V _{GS} =0V, I _{DS} =3mA	100	-	-	V
Zero Gate Voltage Drain Current	I _{DSS}	V _{GS} =0V, V _{DS} =100V	-	-	50	µA
Gate-Body Leakage	I _{GSS}	V _{GS} =±20V, V _{DS} =0V	-	-	200	nA
ON Characteristics						
Gate Threshold Voltage	V _{TH}	V _{DS} =V _{GS} , I _{DS} =8mA	2.5	-	3.5	V
Drain-Source On-State Resistance	R _{DS(on)}	V _{GS} =10V, I _{DS} =100A	-	1.0	1.1	mΩ
Gate Resistance	R _G		-	1.9	2.9	Ω
Forward Transconductance	g _{fs}	V _{DS} > 2 I _D R _{DS(on)M} ^{Note1} , I _D =100A	-	127	-	S
Dynamic Characteristics						
Input Capacitance	C _{iss}	V _{DS} =25V	-	62520	-	pF
Output Capacitance	C _{oss}	V _{GS} =0V	-	2848	-	
Reverse Transfer Capacitance	C _{rss}	Freq.=1MHz	-	2014	-	
Switching Characteristics						
Turn-On Delay Time	t _{d(on)}	V _{DS} =50V V _{GS} =10V I _{DS} =280A	-	164	-	ns
Rise Time	t _r		-	68	-	
Turn-Off Delay Time	t _{d(off)}		-	260	-	
Fall Time	t _f		-	76	-	
Total Gate Charge at 10V	Q _g	V _{DS} =50V	-	449	-	nC
Gate to Source Charge	Q _{gs}	V _{GS} =10V	-	307	-	
Gate to Drain Charge	Q _{gd}	I _{DS} =280A	-	221	-	
Reverse Diode Characteristics						
Drain-Source Diode Forward Voltage	V _F	T _J =25°C, I _F =300A	-	-	1.0	V
Diode Continuous Forward Current	I _F		-	-	445	A
Diode Pulsed Current ^{Note1}	I _{F,pulse}		-	-	1600	A
Reverse Recovery time	T _{RR}	I _F =0.5V, I _R =1.0A, I _{RR} =0.25A	-	-	380	ns

Notes:

1. Pulse Test: Pulse Width ≤ 300 μs, Duty Cycle > 2%.



Typical Characteristics

Fig 1. Power dissipation

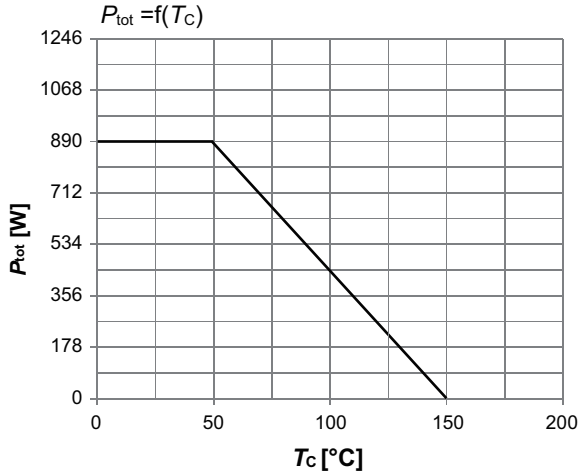

Fig 2. Drain current

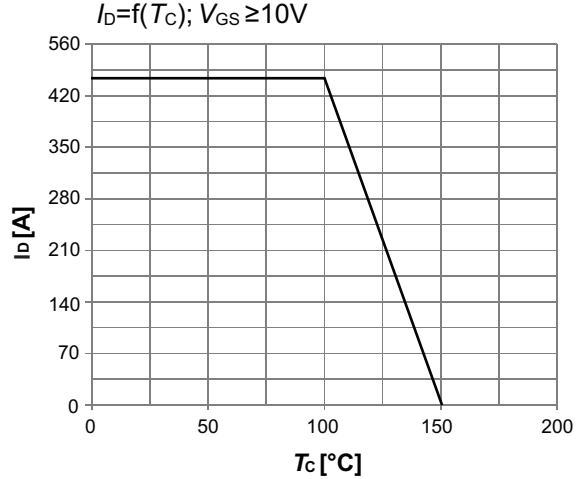

Fig 3. Safe operating area

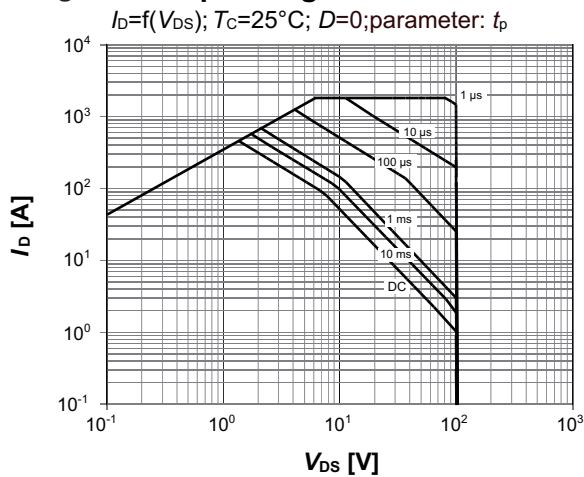

Fig 4. Maximum Transient Thermal Impedance

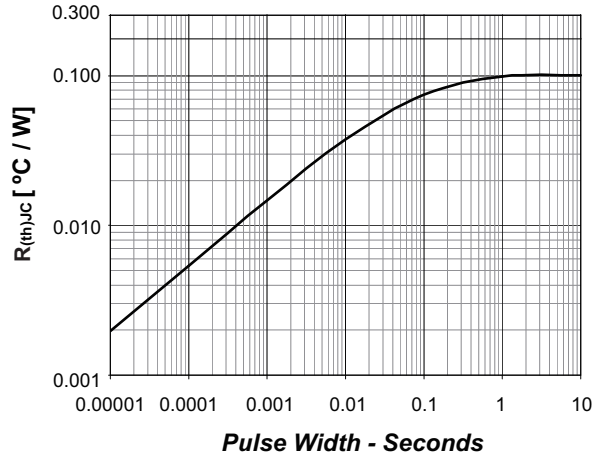

Fig 5. Typ. output characteristics

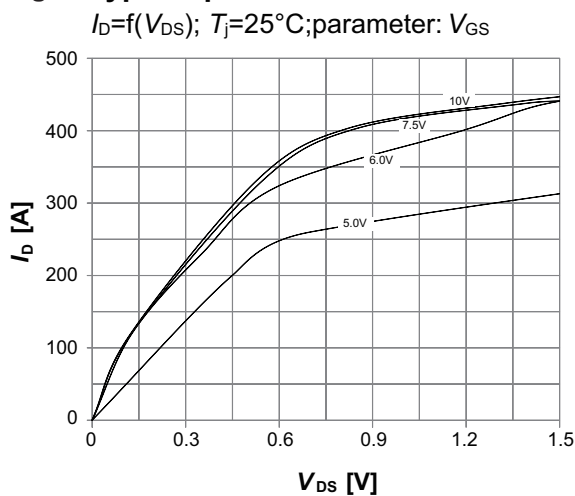
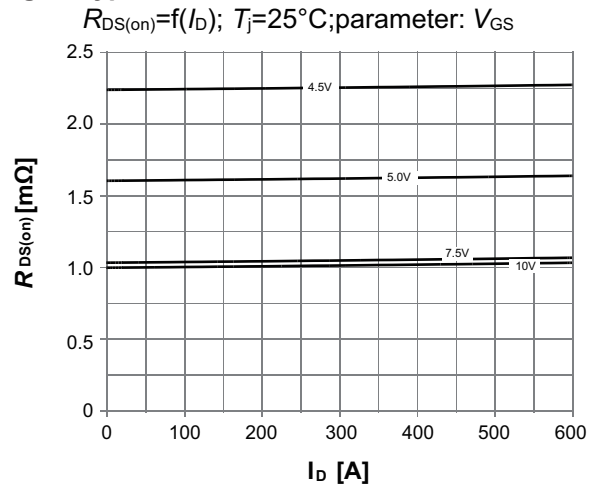

Fig 6. Typ. drain-source on resistance





Typical Characteristics

Fig 7. Typ. transfer characteristics

$I_D=f(V_{GS}); |V_{DS}|>2|I_D|R_{DS(on)max}; \text{parameter: } T_j$

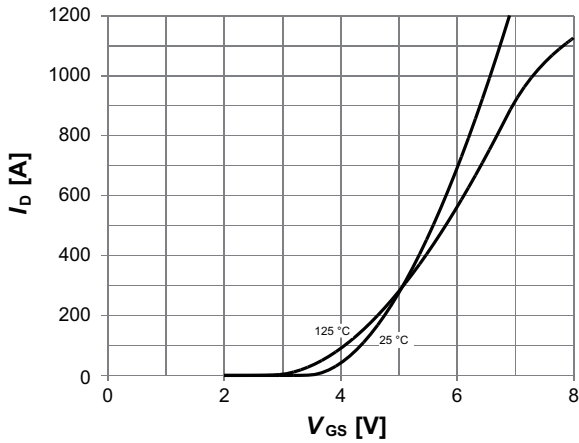

Fig 8. Typ. forward transconductance

$g_{fs}=f(I_D); T_j=25^\circ\text{C}$

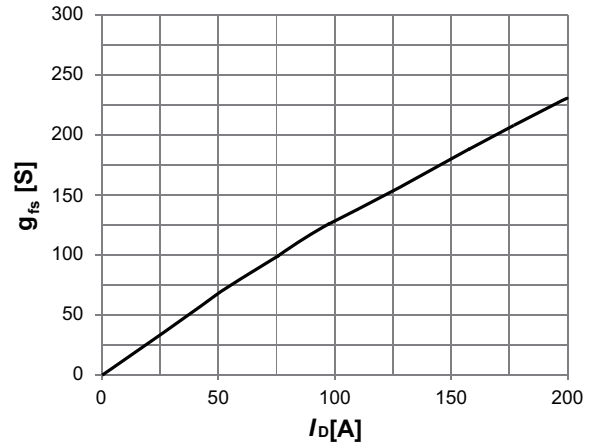

Fig 9. Drain-source on-state resistance

$R_{DS(on)}=f(T_j); I_D=150\text{A}; V_{GS}=10\text{V}$

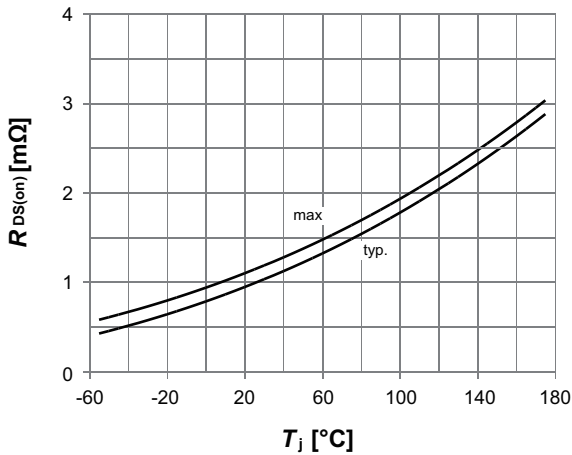

Fig 10. Typ. gate threshold voltage

$V_{GS(th)}=f(T_j); V_{GS}=V_{DS}; \text{parameter: } I_D$

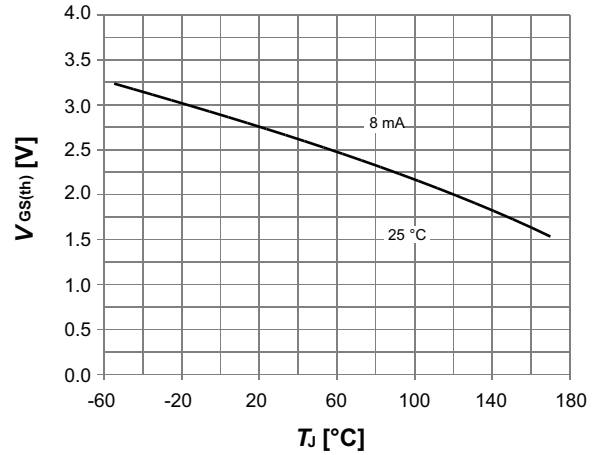

Fig 11. Typ. capacitances

$C=f(V_{DS}); V_{GS}=0\text{V}; f=1\text{MHz}$

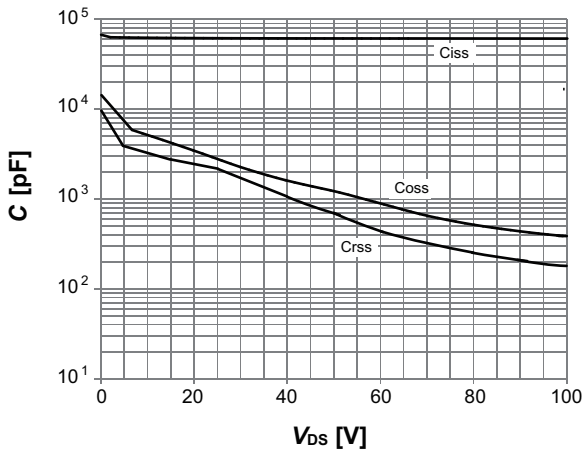
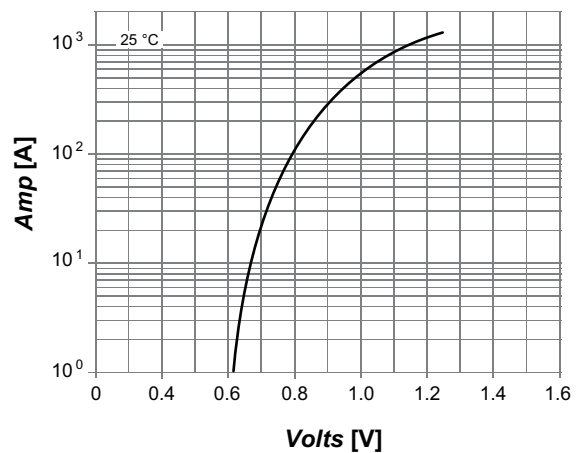

Fig 12. Typical forward characteristics of reverse diode





Typical Characteristics

Fig 13. Forward derating curve of reverse diode

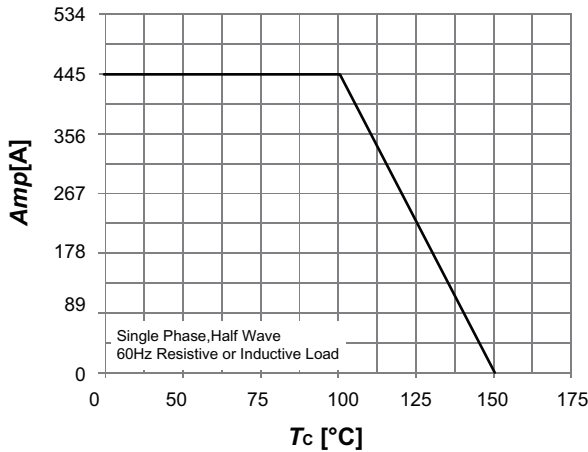

Fig 14. Peak forward surge current of reverse diode

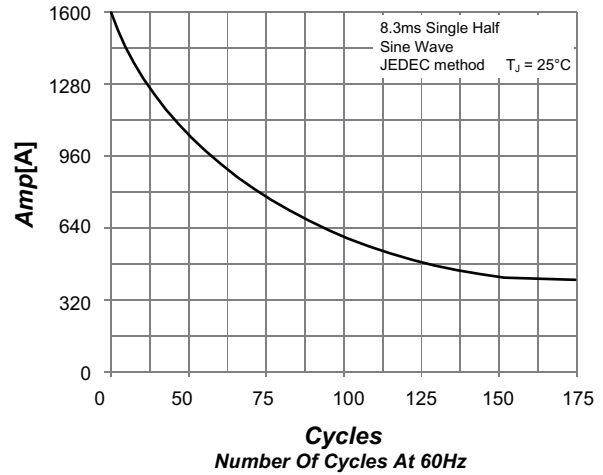

Fig 15. Typical reverse diode characteristics

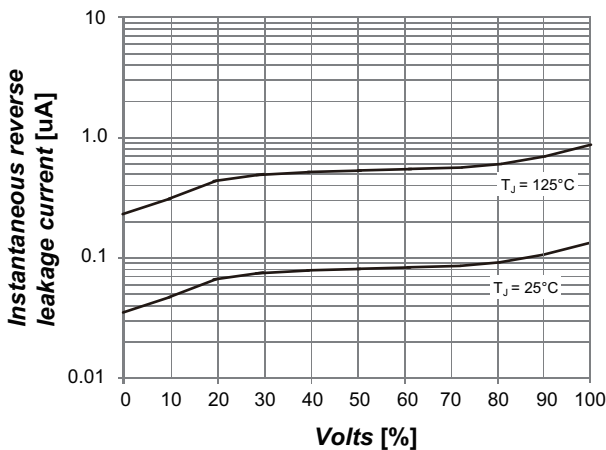

Fig 16. Typ. gate charge

$V_{GS}=f(Q_{gate}); I_D=100A$ pulsed; parameter: V_{DD}

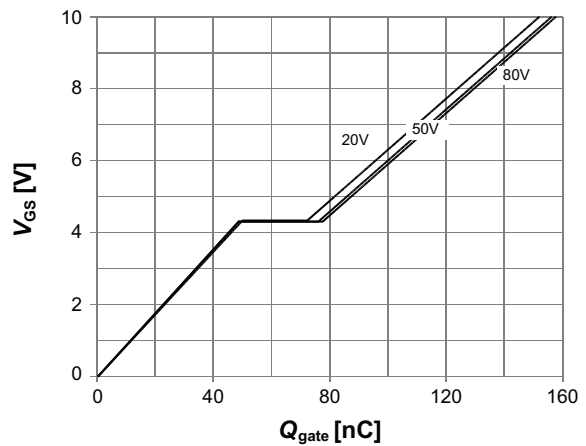
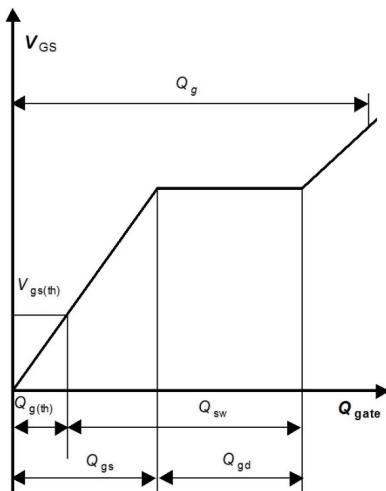

Fig 17. Gate charge waveforms





Disclaimer

DACO Semiconductor reserve the right to make modifications, enhancements, improvements, corrections or other changes without further notice to this document and any product described herein.

DACO Semiconductor makes no warranty, representation or guarantee regarding the suitability of its products for any particular purpose, nor does DACO Semiconductor assume any liability arising out of the application or use of any product or circuit, and specifically disclaims any and all liability, including without limitation special, consequential or incidental damages.

Purchasers is responsible for its products and applications using DACO Semiconductor products, including compliance with all laws, regulations and safety requirements or standards, regardless of any support or applications information provided by DACO Semiconductor. "Typical" parameters which may be provided in DACO Semiconductor data sheets and/or specifications can and do vary in different applications and actual performance may vary over time. All operating parameters, including "Typicals" must be validated for each customer application by customer's technical experts.

DACO Semiconductor products are not designed, authorized or warranted to be suitable for use in life support, life-critical or safety-critical systems or equipment, nor in applications where failure or malfunction of DACO Semiconductor's product can reasonably be expected to result in personal injury, death or severe property or environmental damage. DACO Semiconductor accept no liability for inclusion and/or use of DACO Semiconductor's products in such equipment or applications and therefore such inclusion and/or use is at the customer's own risk.

Purchasers buy or use DACO Semiconductor products for any such unintended or unauthorized application, Purchasers shall indemnify and hold DACO Semiconductor and its suppliers and distributors harmless against all claims, costs, damages, and expenses, and reasonable attorney fees arising out of, directly or indirectly, any claim of personal injury or death associated with such unintended or unauthorized use, even if such claim alleges that DACO Semiconductor was negligent regarding the design or manufacture of the part.

No part of this publication may be reproduced or transmitted in any form or by any means, electronic or mechanical, including photocopying and recording, or any information storage or retrieval system, or otherwise, without the prior written permission of DACO Semiconductor Co., Ltd.