

**Appearance & Shape:** To be free from any defect such as flow, burrs, unevenness etc, As per IEC standards.

**Effective Parameters irrespective of material grade (per piece)**

- Effective Length ( $L_e$ ): mm
- Effective Area ( $A_e$ ): mm<sup>2</sup>
- Effective Area ( $A_{Min}$ ): mm<sup>2</sup>
- Effective Volume ( $V_e$ ): mm<sup>3</sup>

**Approximate weight: 4.0 g/pc**



**R0625 OL**

Material Grade	Initial Permeability ( $\mu_{iac}$ )	Ordering code
CF139	2100 ±20%	CF139 R0630

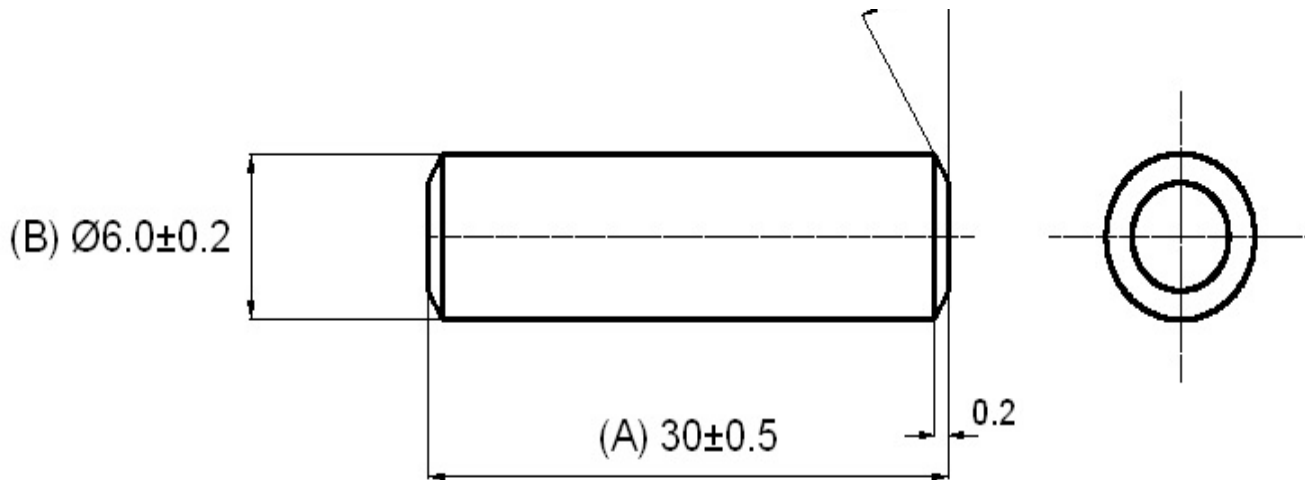

For Cosmo Ferrites Limited-INDIA

Checked By: A.K.

Approved By: B.S.

Authorized By: KSR

Date: 28-07-2014 (ISSUE NO.1)

Customer's Approval

Authorized Signatory:

Name:

Date:



SEMIC TRADE, s.r.o.

Volutová 2521/18

158 00 Praha 5

Czech Republic

[www.semic.cz](http://www.semic.cz)

[semic@semic.cz](mailto:semic@semic.cz)

tel.: +420 251 625 331, 332, 377

fax: +420 251 626 252, 393

For general terms and conditions please visit:

[http://www.cosmoferrites.com/Downloads/Downloads/bcb70e7c-ae33-40ec-a881-0d5120db57b6\\_GTC.pdf](http://www.cosmoferrites.com/Downloads/Downloads/bcb70e7c-ae33-40ec-a881-0d5120db57b6_GTC.pdf)