



MSCSM120SKM31CTBL1NG

Buck Chopper SiC MOSFET Power Module

Product Overview

The MSCSM120SKM31CTBL1NG device is a 1200 V, 79 A buck chopper silicon carbide (SiC) MOSFET power module.

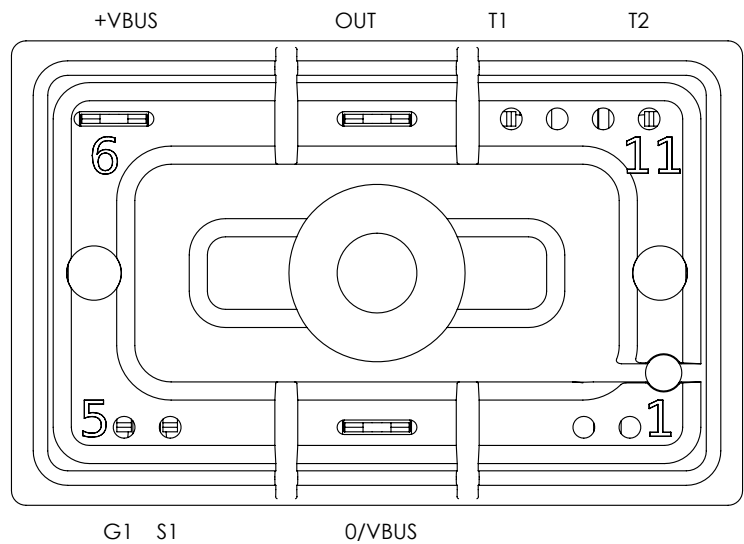
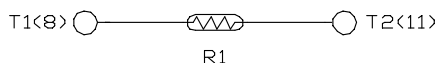
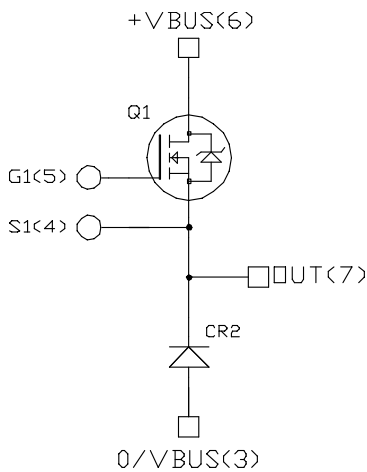
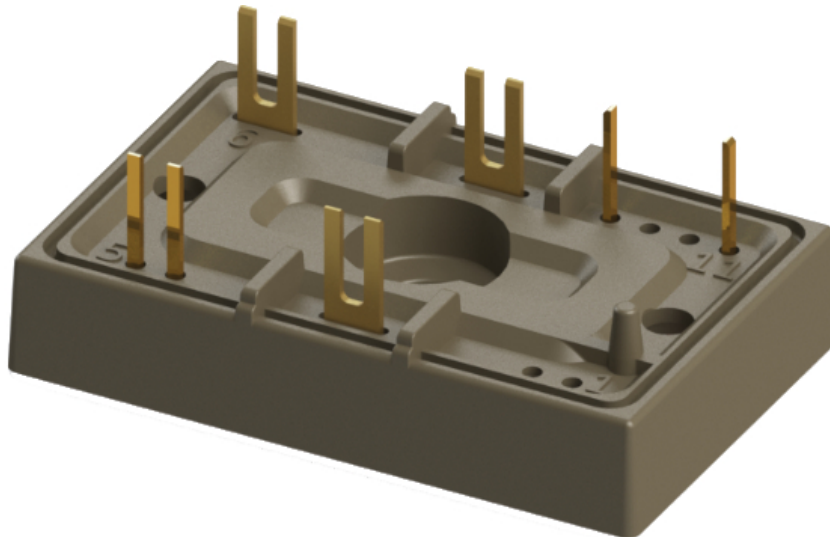

All ratings at $T_J = 25\text{ }^\circ\text{C}$, unless otherwise specified.

Caution: These devices are sensitive to electrostatic discharge. Proper handling procedures must be followed.

Features

The following are the key features of MSCSM120SKM31CTBL1NG device:

- SiC Power MOSFET
 - Low $R_{DS(on)}$
 - High speed switching
- SiC Schottky Diode
 - Zero reverse recovery
 - Zero forward recovery
 - Temperature independent switching behavior
 - Positive temperature coefficient on V_F
- Very low stray inductance
- Ultra-low weight and profile
- Kelvin source for easy drive
- Si_3N_4 substrate with thick copper for improved thermal performance
- Internal thermistor for temperature monitoring
- Extended temperature range

Benefits

The following are the benefits of MSCSM120SKM31CTBL1NG device:

- High efficiency converter
- Outstanding performance at high frequency operation
- Direct mounting to heatsink (isolated package)
- Low junction-to-case thermal resistance
- Low profile
- RoHS Compliant
- Solderable terminals both for power and signal for easy PCB mounting
- Very integrated power conversion system

Application

The following are the applications of MSCSM120SKM31CTBL1NG device:

- High reliability power systems
- High Efficiency AC/DC and DC/AC converters
- Motor control

1. Electrical Specifications

This section provides the electrical specifications of the MSCSM120SKM31CTBL1NG device.

1.1 SiC MOSFET Characteristics (Per SiC MOSFET)

The following table lists the absolute maximum ratings of MSCSM120SKM31CTBL1NG device.

Table 1-1. Absolute Maximum Ratings

Symbol	Parameter	Maximum Ratings	Unit
V_{DSS}	Drain-Source voltage	1200	V
I_D	Continuous drain current	$T_H = 25\text{ }^\circ\text{C}$	79
		$T_H = 80\text{ }^\circ\text{C}$	63
I_{DM}	Pulsed drain current	160	
V_{GS}	Gate-Source voltage	-10/25	V
$R_{DS(on)}$	Drain-Source ON resistance	31	m Ω
P_D	Power dissipation	$T_H = 25\text{ }^\circ\text{C}$	310

The following table lists the electrical characteristics of MSCSM120SKM31CTBL1NG device.

Table 1-2. Electrical Characteristics

Symbol	Characteristic	Test Conditions	Min	Typ	Max	Unit	
I_{DSS}	Zero gate voltage drain current	$V_{GS} = 0\text{ V}$ $V_{DS} = 1200\text{ V}$	—	10	100	μA	
$R_{DS(on)}$	Drain-Source on resistance	$V_{GS} = 20\text{ V}$ $I_D = 40\text{ A}$	$T_J = 25\text{ }^\circ\text{C}$	—	25	31	m Ω
			$T_J = 175\text{ }^\circ\text{C}$	—	40	—	
$V_{GS(th)}$	Gate threshold voltage	$V_{GS} = V_{DS}$ $I_D = 1\text{ mA}$	1.8	2.8	—	V	
I_{GSS}	Gate-Source leakage current	$V_{GS} = 20\text{ V}$ $V_{DS} = 0\text{ V}$	—	—	150	nA	

MSCSM120SKM31CTBL1NG

Electrical Specifications

The following table lists the dynamic characteristics of MSCSM120SKM31CTBL1NG device.

Table 1-3. Dynamic Characteristics

Symbol	Characteristic	Test Conditions	Min	Typ	Max	Unit
C _{iss}	Input capacitance	V _{GS} = 0 V	—	3020	—	pF
C _{oss}	Output capacitance	V _{DS} = 1000 V	—	270	—	
C _{rss}	Reverse transfer capacitance	f = 1 MHz	—	25	—	
Q _g	Total gate charge	V _{GS} = -5 V/20 V	—	232	—	nC
Q _{gs}	Gate-Source charge	V _{Bus} = 800 V	—	41	—	
Q _{gd}	Gate-Drain charge	I _D = 40 A	—	50	—	
T _{d(on)}	Turn-on delay time	V _{GS} = -5 V/20 V	—	30	—	ns
T _r	Rise time	V _{Bus} = 600 V	—	30	—	
T _{d(off)}	Turn-off delay time	I _D = 50 A	—	50	—	
T _f	Fall time	R _{Gon} = 8 Ω R _{Goff} = 4.7 Ω	—	25	—	
E _{on}	Turn-on energy	V _{GS} = -5 V/20 V	T _J = 150 °C	—	0.99	mJ
E _{off}	Turn-off energy	V _{Bus} = 600 V I _D = 50 A R _{Gon} = 8 Ω R _{Goff} = 4.7 Ω	T _J = 150 °C	—	0.66	
R _{Gint}	Internal gate resistance		—	0.88	—	Ω
R _{thJH}	Junction-to-heatsink thermal resistance	λ = 3.4 W/mK	—	0.483	—	°C/W

The following table lists the body diode ratings and characteristics of MSCSM120SKM31CTBL1NG device.

Table 1-4. Body Diode Ratings and Characteristics

Symbol	Characteristic	Test Conditions	Min	Typ	Max	Unit
V _{SD}	Diode forward voltage	V _{GS} = 0 V I _{SD} = 40 A	—	4	—	V
		V _{GS} = -5 V I _{SD} = 40 A	—	4.2	—	
t _{rr}	Reverse recovery time	I _{SD} = 40 A	—	90	—	ns
Q _{rr}	Reverse recovery charge	V _{GS} = -5 V	—	550	—	nC
I _{rr}	Reverse recovery current	V _R = 800 V di _F /dt = 1000 A/μs	—	13.5	—	A

1.2 SiC Diode Ratings and Characteristics (Per SiC Diode)

The following table lists the SiC diode ratings and characteristics of MSCSM120SKM31CTBL1NG device.

Table 1-5. SiC Diode Ratings and Characteristics

Symbol	Characteristic	Test Conditions	Min	Typ	Max	Unit	
V_{RRM}	Peak repetitive reverse voltage		—	—	1200	V	
I_{RM}	Reverse leakage current	$V_R = 1200\text{ V}$	$T_J = 25\text{ °C}$	—	10	200	μA
			$T_J = 175\text{ °C}$	—	250	—	
I_F	DC forward current		$T_H = 100\text{ °C}$	—	50	—	A
V_F	Diode forward voltage	$I_F = 50\text{ A}$	$T_J = 25\text{ °C}$	—	1.5	1.8	V
			$T_J = 175\text{ °C}$	—	2.1	—	
Q_C	Total capacitive charge	$V_R = 600\text{ V}$	—	224	—	nC	
C	Total capacitance	$f = 1\text{ MHz}$ $V_R = 400\text{ V}$	—	246	—	pF	
		$f = 1\text{ MHz}$ $V_R = 800\text{ V}$	—	182	—		
R_{thJH}	Junction-to-heatsink thermal resistance	$\lambda_{paste} = 3.4\text{ W/mK}$	—	0.635	—	$^{\circ}\text{C/W}$	

1.3 Thermal and Package Characteristics

The following table lists the thermal and package characteristics of the MSCSM120SKM31CTBL1NG device.

Table 1-6. Thermal and Package Characteristics

Symbol	Characteristic	Min	Typ	Max	Unit	
V_{ISOL}	RMS isolation voltage, any terminal to case $t = 1\text{ min}$, 50 Hz/60 Hz	2500	—	—	V	
T_J	Operating junction temperature range	-55	—	175	$^{\circ}\text{C}$	
T_{JOP}	Recommended junction temperature under switching conditions	-55	—	$T_{Jmax}-25$		
T_{STG}	Storage case temperature	-55	—	125		
T_C	Operating case temperature	-55	—	125		
Torque	Mounting torque	To heatsink	M4	1.5		2
Wt	Package weight	—	13.5	—	g	

MSCSM120SKM31CTBL1NG

Electrical Specifications

The following table lists the temperature sensor NTC of the MSCSM120SKM31CTBL1NG device.

Table 1-7. Temperature Sensor NTC

Symbol	Characteristic	Min	Typ	Max	Unit
R ₂₅	Resistance at 25°C	—	50	—	kΩ
ΔR ₂₅ /R ₂₅	—	—	5	—	%
B _{25/85}	T ₂₅ = 298.15 K	—	3952	—	K
ΔB/B	—	T _C = 100°C	4	—	%

$$R_T = \frac{R_{25}}{\exp\left[B_{25/85}\left(\frac{1}{T_{25}} - \frac{1}{T}\right)\right]}$$

T: Thermistor temperature
R_T: Thermistor value at T

Note: See [APT0406—Using NTC Temperature Sensor Integrated into Power Module](#) for more information.

1.4 Typical SiC MOSFET Performance Curve

This section shows the typical SiC MOSFET performance curves of the MSCSM120SKM31CTBL1NG device.

Figure 1-1. Junction-to-Heatsink Thermal Impedance

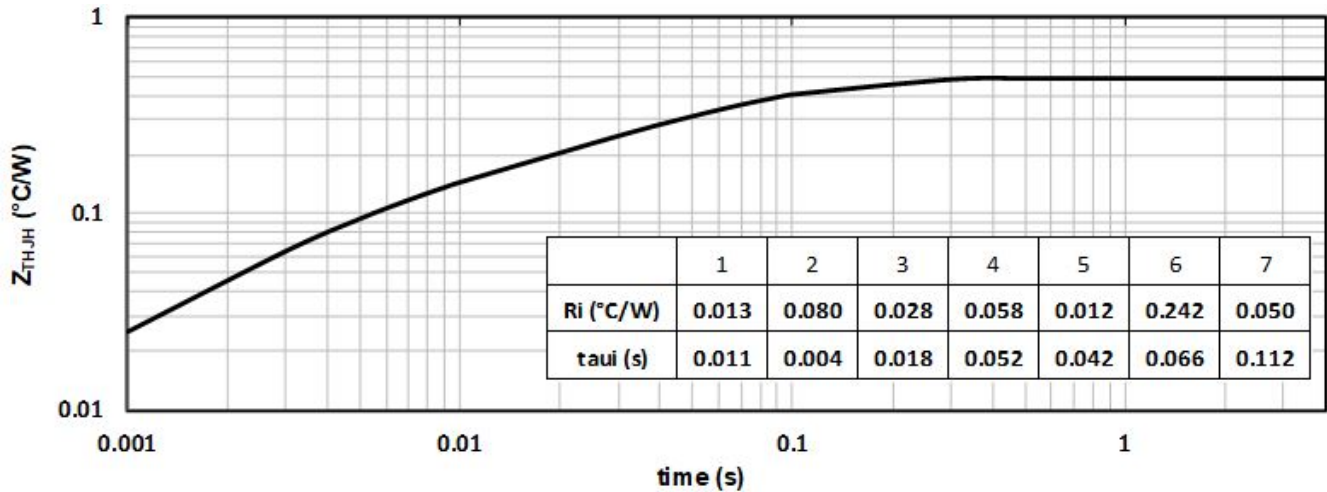

MSCSM120SKM31CTBL1NG

Electrical Specifications

Figure 1-2. Output Characteristics, $T_J = 25^\circ\text{C}$

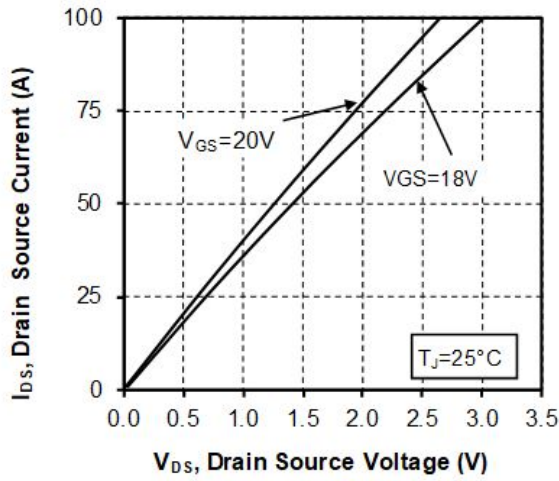

Figure 1-3. Output Characteristics, $T_J = 175^\circ\text{C}$

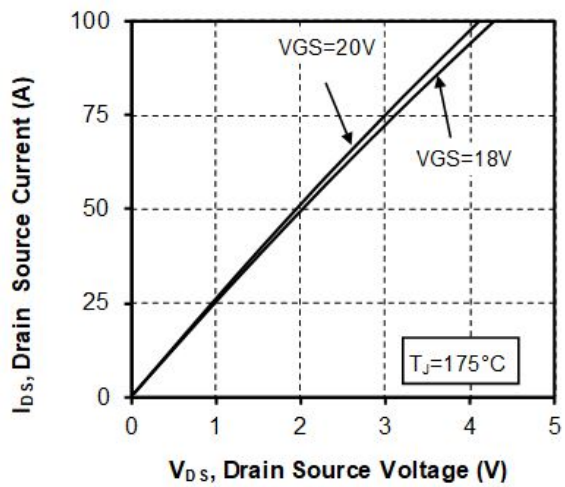

Figure 1-4. Normalized $R_{DS(on)}$ vs. Temperature

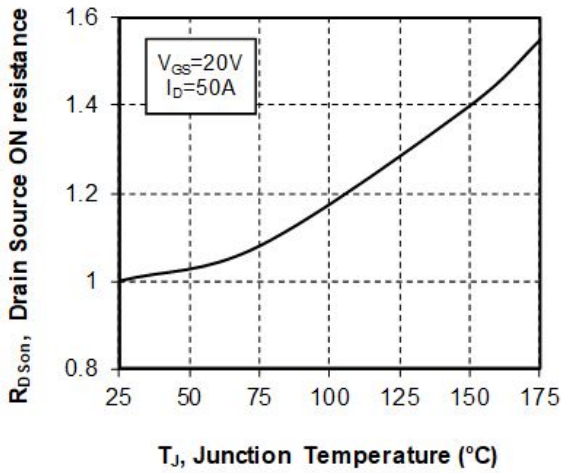

Figure 1-5. Transfer Characteristics

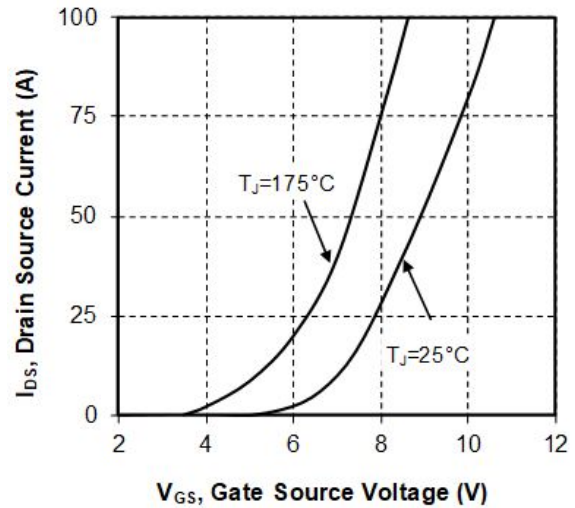

Figure 1-6. Switching Energy vs. Rg

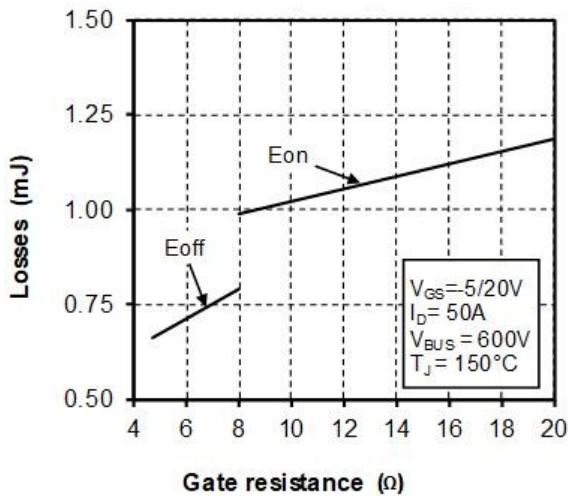

Figure 1-7. Switching Energy vs. Current

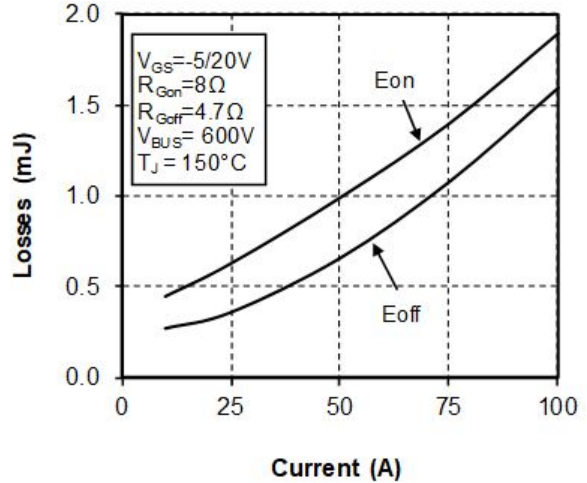

Figure 1-8. Capacitance vs. Drain Source Voltage

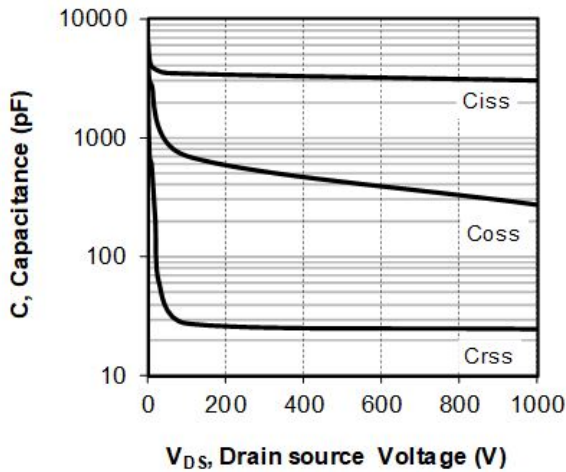

Figure 1-9. Gate Charge vs. Gate Source Voltage

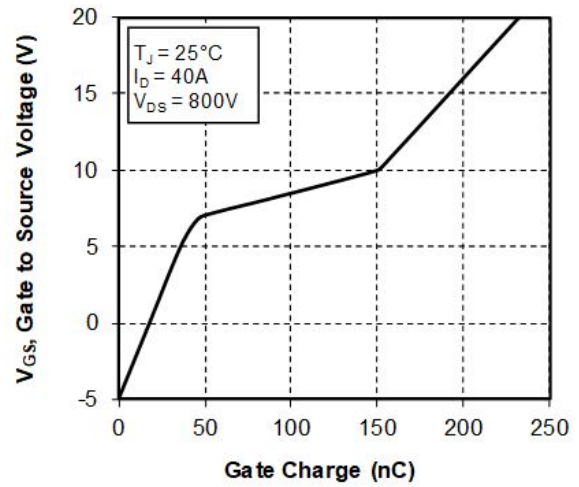

Figure 1-10. Body Diode Characteristics, $T_J = 25^\circ\text{C}$

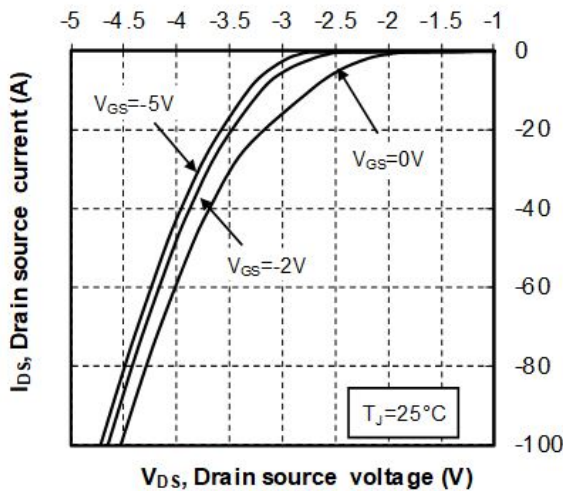

Figure 1-11. 3rd Quadrant Characteristics, $T_J = 25^\circ\text{C}$

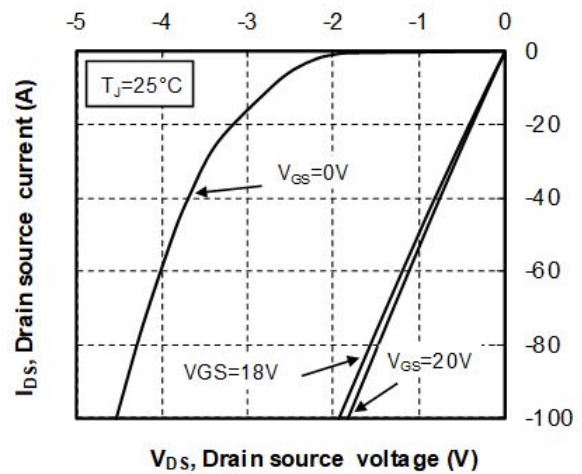

Figure 1-12. Body Diode Characteristics, $T_J = 175^\circ\text{C}$

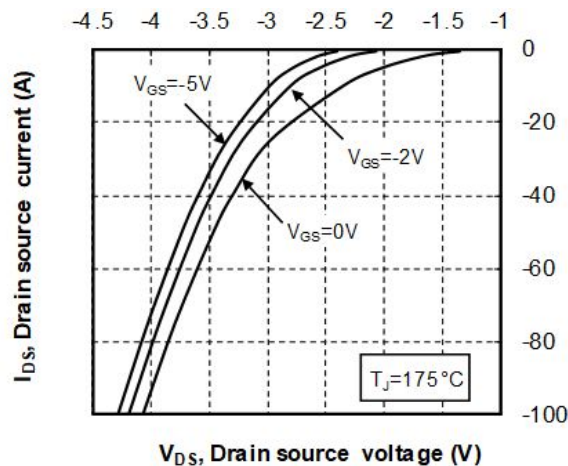

Figure 1-13. 3rd Quadrant Characteristics, $T_J = 175^\circ\text{C}$

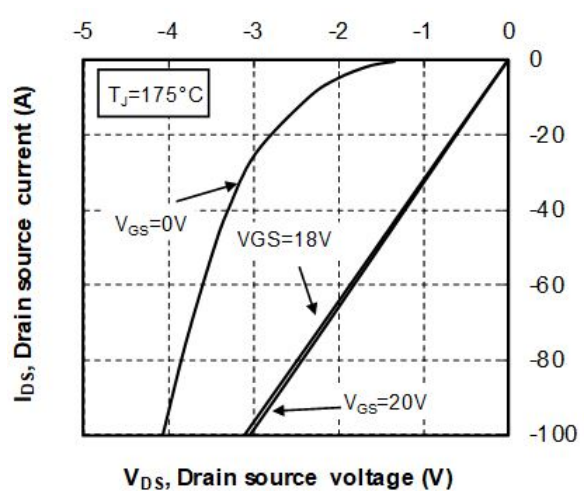
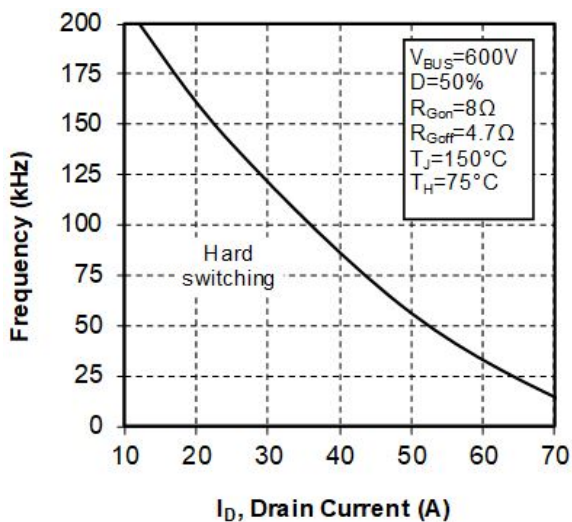

Figure 1-14. Operating Frequency vs Drain Current



1.5 Typical SiC Diode Performance Curves

This section shows the typical SiC diode performance curves of the MSCSM120SKM31CTBL1NG device.

Figure 1-15. Junction-to-Heatsink Thermal Impedance

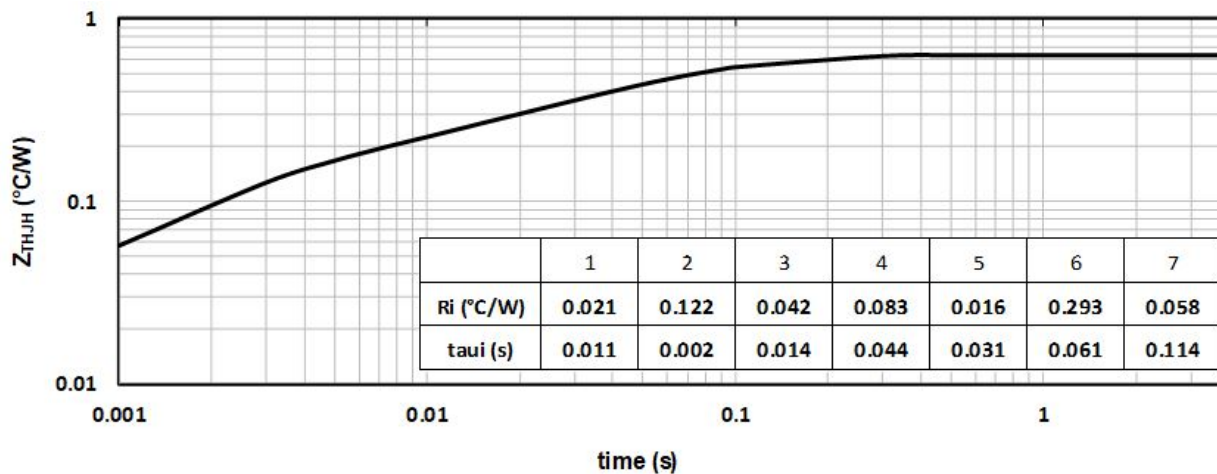

Figure 1-16. Forward Characteristics

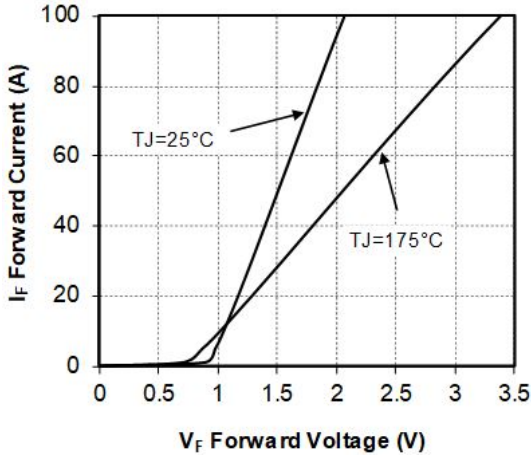
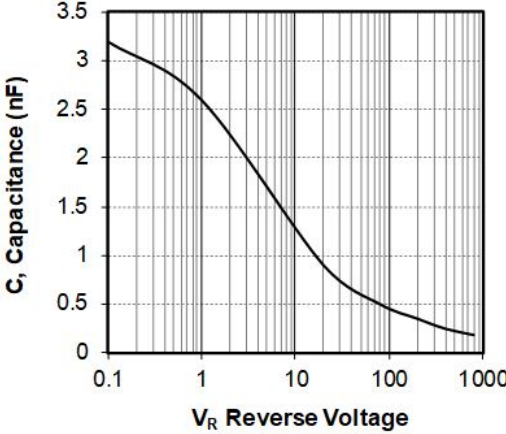

Figure 1-17. Capacitance vs. Reverse Voltage



2. Package Specifications

The following section shows the package specification of the MSCSM120SKM31CTBL1NG device.

2.1 Package Outline

The following figure shows the package outline drawing of the MSCSM120SKM31CTBL1NG device. The dimensions in the following figure are in millimeters.

Figure 2-1. Package Outline Drawing

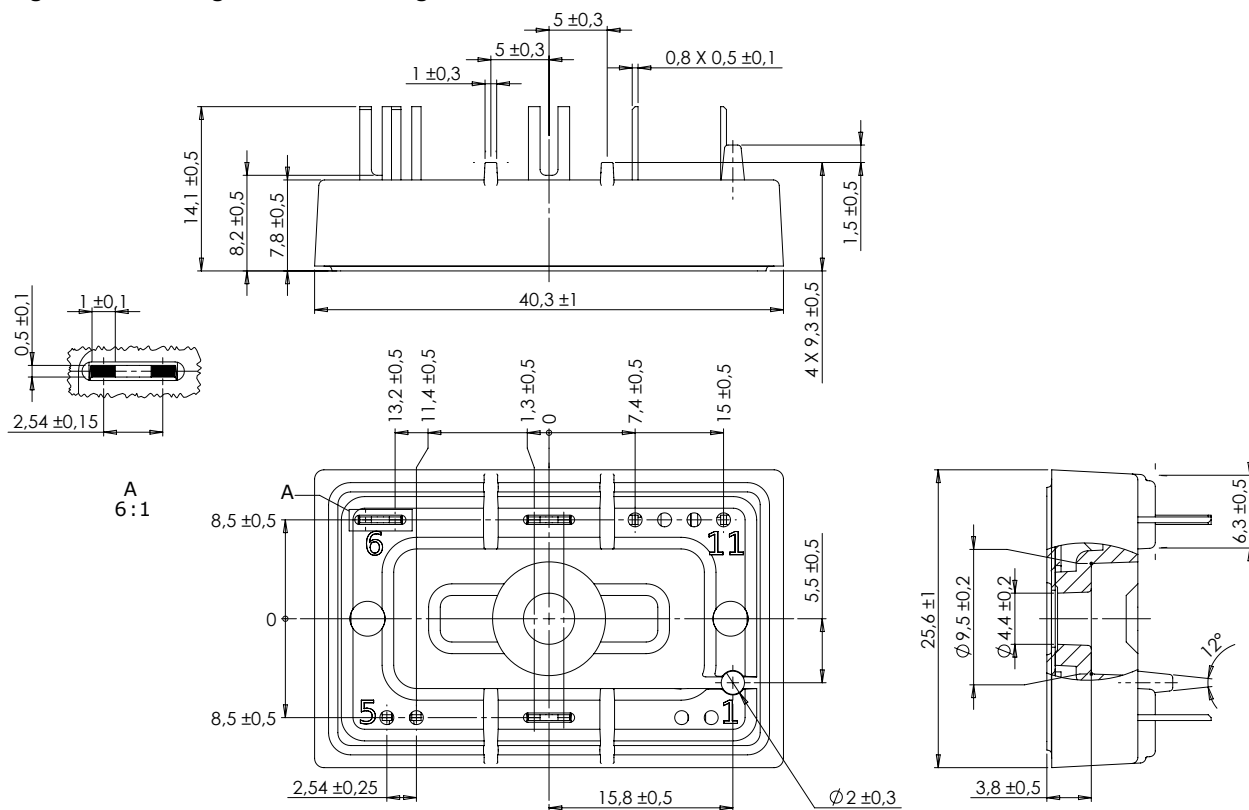

3. Revision History

Revision	Date	Description
A	07/2021	Initial Revision

The Microchip Website

Microchip provides online support via our website at www.microchip.com/. This website is used to make files and information easily available to customers. Some of the content available includes:

- **Product Support** – Data sheets and errata, application notes and sample programs, design resources, user's guides and hardware support documents, latest software releases and archived software
- **General Technical Support** – Frequently Asked Questions (FAQs), technical support requests, online discussion groups, Microchip design partner program member listing
- **Business of Microchip** – Product selector and ordering guides, latest Microchip press releases, listing of seminars and events, listings of Microchip sales offices, distributors and factory representatives

Product Change Notification Service

Microchip's product change notification service helps keep customers current on Microchip products. Subscribers will receive email notification whenever there are changes, updates, revisions or errata related to a specified product family or development tool of interest.

To register, go to www.microchip.com/pcn and follow the registration instructions.

Customer Support

Users of Microchip products can receive assistance through several channels:

- Distributor or Representative
- Local Sales Office
- Embedded Solutions Engineer (ESE)
- Technical Support

Customers should contact their distributor, representative or ESE for support. Local sales offices are also available to help customers. A listing of sales offices and locations is included in this document.

Technical support is available through the website at: www.microchip.com/support

Microchip Devices Code Protection Feature

Note the following details of the code protection feature on Microchip devices:

- Microchip products meet the specifications contained in their particular Microchip Data Sheet.
- Microchip believes that its family of products is secure when used in the intended manner and under normal conditions.
- There are dishonest and possibly illegal methods being used in attempts to breach the code protection features of the Microchip devices. We believe that these methods require using the Microchip products in a manner outside the operating specifications contained in Microchip's Data Sheets. Attempts to breach these code protection features, most likely, cannot be accomplished without violating Microchip's intellectual property rights.
- Microchip is willing to work with any customer who is concerned about the integrity of its code.
- Neither Microchip nor any other semiconductor manufacturer can guarantee the security of its code. Code protection does not mean that we are guaranteeing the product is "unbreakable." Code protection is constantly evolving. We at Microchip are committed to continuously improving the code protection features of our products. Attempts to break Microchip's code protection feature may be a violation of the Digital Millennium Copyright Act. If such acts allow unauthorized access to your software or other copyrighted work, you may have a right to sue for relief under that Act.

Legal Notice

Information contained in this publication is provided for the sole purpose of designing with and using Microchip products. Information regarding device applications and the like is provided only for your convenience and may be superseded by updates. It is your responsibility to ensure that your application meets with your specifications.

THIS INFORMATION IS PROVIDED BY MICROCHIP "AS IS". MICROCHIP MAKES NO REPRESENTATIONS OR WARRANTIES OF ANY KIND WHETHER EXPRESS OR IMPLIED, WRITTEN OR ORAL, STATUTORY OR OTHERWISE, RELATED TO THE INFORMATION INCLUDING BUT NOT LIMITED TO ANY IMPLIED WARRANTIES OF NON-INFRINGEMENT, MERCHANTABILITY, AND FITNESS FOR A PARTICULAR PURPOSE OR WARRANTIES RELATED TO ITS CONDITION, QUALITY, OR PERFORMANCE.

IN NO EVENT WILL MICROCHIP BE LIABLE FOR ANY INDIRECT, SPECIAL, PUNITIVE, INCIDENTAL OR CONSEQUENTIAL LOSS, DAMAGE, COST OR EXPENSE OF ANY KIND WHATSOEVER RELATED TO THE INFORMATION OR ITS USE, HOWEVER CAUSED, EVEN IF MICROCHIP HAS BEEN ADVISED OF THE POSSIBILITY OR THE DAMAGES ARE FORESEEABLE. TO THE FULLEST EXTENT ALLOWED BY LAW, MICROCHIP'S TOTAL LIABILITY ON ALL CLAIMS IN ANY WAY RELATED TO THE INFORMATION OR ITS USE WILL NOT EXCEED THE AMOUNT OF FEES, IF ANY, THAT YOU HAVE PAID DIRECTLY TO MICROCHIP FOR THE INFORMATION. Use of Microchip devices in life support and/or safety applications is entirely at the buyer's risk, and the buyer agrees to defend, indemnify and hold harmless Microchip from any and all damages, claims, suits, or expenses resulting from such use. No licenses are conveyed, implicitly or otherwise, under any Microchip intellectual property rights unless otherwise stated.

Trademarks

The Microchip name and logo, the Microchip logo, Adaptec, AnyRate, AVR, AVR logo, AVR Freaks, BesTime, BitCloud, chipKIT, chipKIT logo, CryptoMemory, CryptoRF, dsPIC, FlashFlex, flexPWR, HELDO, IGLOO, JukeBlox, KeeLoq, Klear, LANCheck, LinkMD, maXStylus, maXTouch, MediaLB, megaAVR, Microsemi, Microsemi logo, MOST, MOST logo, MPLAB, OptoLyzer, PackeTime, PIC, picoPower, PICSTART, PIC32 logo, PolarFire, Prochip Designer, QTouch, SAM-BA, SenGenuity, SpyNIC, SST, SST Logo, SuperFlash, Symmetricom, SyncServer, Tachyon, TimeSource, tinyAVR, UNI/O, Vectron, and XMEGA are registered trademarks of Microchip Technology Incorporated in the U.S.A. and other countries.

AgileSwitch, APT, ClockWorks, The Embedded Control Solutions Company, EtherSynch, FlashTec, Hyper Speed Control, HyperLight Load, IntelliMOS, Libero, motorBench, mTouch, Powermite 3, Precision Edge, ProASIC, ProASIC Plus, ProASIC Plus logo, Quiet-Wire, SmartFusion, SyncWorld, Temux, TimeCesium, TimeHub, TimePictra, TimeProvider, WinPath, and ZL are registered trademarks of Microchip Technology Incorporated in the U.S.A.

Adjacent Key Suppression, AKS, Analog-for-the-Digital Age, Any Capacitor, AnyIn, AnyOut, Augmented Switching, BlueSky, BodyCom, CodeGuard, CryptoAuthentication, CryptoAutomotive, CryptoCompanion, CryptoController, dsPICDEM, dsPICDEM.net, Dynamic Average Matching, DAM, ECAN, Espresso T1S, EtherGREEN, IdealBridge, In-Circuit Serial Programming, ICSP, INICnet, Intelligent Paralleling, Inter-Chip Connectivity, JitterBlocker, maxCrypto, maxView, memBrain, Mindi, MiWi, MPASM, MPF, MPLAB Certified logo, MPLIB, MPLINK, MultiTRAK, NetDetach, Omniscient Code Generation, PICDEM, PICDEM.net, PICKit, PICtail, PowerSmart, PureSilicon, QMatrix, REAL ICE, Ripple Blocker, RTAX, RTG4, SAM-ICE, Serial Quad I/O, simpleMAP, SimpliPHY, SmartBuffer, SMART-I.S., storClad, SQL, SuperSwitcher, SuperSwitcher II, Switchtec, SynchroPHY, Total Endurance, TSHARC, USBCheck, VariSense, VectorBlox, VeriPHY, ViewSpan, WiperLock, XpressConnect, and ZENA are trademarks of Microchip Technology Incorporated in the U.S.A. and other countries.

SQTP is a service mark of Microchip Technology Incorporated in the U.S.A.

The Adaptec logo, Frequency on Demand, Silicon Storage Technology, and Symmcom are registered trademarks of Microchip Technology Inc. in other countries.

GestIC is a registered trademark of Microchip Technology Germany II GmbH & Co. KG, a subsidiary of Microchip Technology Inc., in other countries.

All other trademarks mentioned herein are property of their respective companies.

© 2021, Microchip Technology Incorporated, Printed in the U.S.A., All Rights Reserved.

ISBN: 978-1-5224-8531-5

Quality Management System

For information regarding Microchip's Quality Management Systems, please visit www.microchip.com/quality.

Worldwide Sales and Service

AMERICAS	ASIA/PACIFIC	ASIA/PACIFIC	EUROPE
<p>Corporate Office 2355 West Chandler Blvd. Chandler, AZ 85224-6199 Tel: 480-792-7200 Tel: 480-792-7277 Technical Support: www.microchip.com/support Web Address: www.microchip.com</p> <p>Atlanta Duluth, GA Tel: 678-957-9614 Fax: 678-957-1455</p> <p>Austin, TX Tel: 512-257-3370</p> <p>Boston Westborough, MA Tel: 774-760-0087 Fax: 774-760-0088</p> <p>Chicago Itasca, IL Tel: 630-285-0071 Fax: 630-285-0075</p> <p>Dallas Addison, TX Tel: 972-818-7423 Fax: 972-818-2924</p> <p>Detroit Novi, MI Tel: 248-848-4000</p> <p>Houston, TX Tel: 281-894-5983</p> <p>Indianapolis Noblesville, IN Tel: 317-773-8323 Fax: 317-773-5453 Tel: 317-536-2380</p> <p>Los Angeles Mission Viejo, CA Tel: 949-462-9523 Fax: 949-462-9608 Tel: 951-273-7800</p> <p>Raleigh, NC Tel: 919-844-7510</p> <p>New York, NY Tel: 631-435-6000</p> <p>San Jose, CA Tel: 408-735-9110 Tel: 408-436-4270</p> <p>Canada - Toronto Tel: 905-695-1980 Fax: 905-695-2078</p>	<p>Australia - Sydney Tel: 61-2-9868-6733</p> <p>China - Beijing Tel: 86-10-8569-7000</p> <p>China - Chengdu Tel: 86-28-8665-5511</p> <p>China - Chongqing Tel: 86-23-8980-9588</p> <p>China - Dongguan Tel: 86-769-8702-9880</p> <p>China - Guangzhou Tel: 86-20-8755-8029</p> <p>China - Hangzhou Tel: 86-571-8792-8115</p> <p>China - Hong Kong SAR Tel: 852-2943-5100</p> <p>China - Nanjing Tel: 86-25-8473-2460</p> <p>China - Qingdao Tel: 86-532-8502-7355</p> <p>China - Shanghai Tel: 86-21-3326-8000</p> <p>China - Shenyang Tel: 86-24-2334-2829</p> <p>China - Shenzhen Tel: 86-755-8864-2200</p> <p>China - Suzhou Tel: 86-186-6233-1526</p> <p>China - Wuhan Tel: 86-27-5980-5300</p> <p>China - Xian Tel: 86-29-8833-7252</p> <p>China - Xiamen Tel: 86-592-2388138</p> <p>China - Zhuhai Tel: 86-756-3210040</p>	<p>India - Bangalore Tel: 91-80-3090-4444</p> <p>India - New Delhi Tel: 91-11-4160-8631</p> <p>India - Pune Tel: 91-20-4121-0141</p> <p>Japan - Osaka Tel: 81-6-6152-7160</p> <p>Japan - Tokyo Tel: 81-3-6880-3770</p> <p>Korea - Daegu Tel: 82-53-744-4301</p> <p>Korea - Seoul Tel: 82-2-554-7200</p> <p>Malaysia - Kuala Lumpur Tel: 60-3-7651-7906</p> <p>Malaysia - Penang Tel: 60-4-227-8870</p> <p>Philippines - Manila Tel: 63-2-634-9065</p> <p>Singapore Tel: 65-6334-8870</p> <p>Taiwan - Hsin Chu Tel: 886-3-577-8366</p> <p>Taiwan - Kaohsiung Tel: 886-7-213-7830</p> <p>Taiwan - Taipei Tel: 886-2-2508-8600</p> <p>Thailand - Bangkok Tel: 66-2-694-1351</p> <p>Vietnam - Ho Chi Minh Tel: 84-28-5448-2100</p>	<p>Austria - Wels Tel: 43-7242-2244-39 Fax: 43-7242-2244-393</p> <p>Denmark - Copenhagen Tel: 45-4485-5910 Fax: 45-4485-2829</p> <p>Finland - Espoo Tel: 358-9-4520-820</p> <p>France - Paris Tel: 33-1-69-53-63-20 Fax: 33-1-69-30-90-79</p> <p>Germany - Garching Tel: 49-8931-9700</p> <p>Germany - Haan Tel: 49-2129-3766400</p> <p>Germany - Heilbronn Tel: 49-7131-72400</p> <p>Germany - Karlsruhe Tel: 49-721-625370</p> <p>Germany - Munich Tel: 49-89-627-144-0 Fax: 49-89-627-144-44</p> <p>Germany - Rosenheim Tel: 49-8031-354-560</p> <p>Israel - Ra'anana Tel: 972-9-744-7705</p> <p>Italy - Milan Tel: 39-0331-742611 Fax: 39-0331-466781</p> <p>Italy - Padova Tel: 39-049-7625286</p> <p>Netherlands - Drunen Tel: 31-416-690399 Fax: 31-416-690340</p> <p>Norway - Trondheim Tel: 47-72884388</p> <p>Poland - Warsaw Tel: 48-22-3325737</p> <p>Romania - Bucharest Tel: 40-21-407-87-50</p> <p>Spain - Madrid Tel: 34-91-708-08-90 Fax: 34-91-708-08-91</p> <p>Sweden - Gothenberg Tel: 46-31-704-60-40</p> <p>Sweden - Stockholm Tel: 46-8-5090-4654</p> <p>UK - Wokingham Tel: 44-118-921-5800 Fax: 44-118-921-5820</p>