

HITPOINT

PB-09S27P-05Q

(ROHS)

DATE:2005.01.21

1 . Electrical Characteristics

VER :.0

Oscillation Frequency (Hz)	2730 ± 500
Operating Voltage (Vp-p)	4.0 ~ 7.0
Rated Voltage (Vp-p)	5.0
Current Consumption (mA/max)	70 at Rated Voltage
Sound Pressure Level (dB/min)	85 at 10cm at Rated Voltage
Coil Resistance (Ω)	32 ± 3
Operating Temperature (°C)	-20 ~ +70
Storage Temperature (°C)	-30 ~ +80
Manual soldering conditions	350±20°C / within 5sec

PS : Vp-p= 1/2duty , square wave

2 . Typical Frequency Response Curve

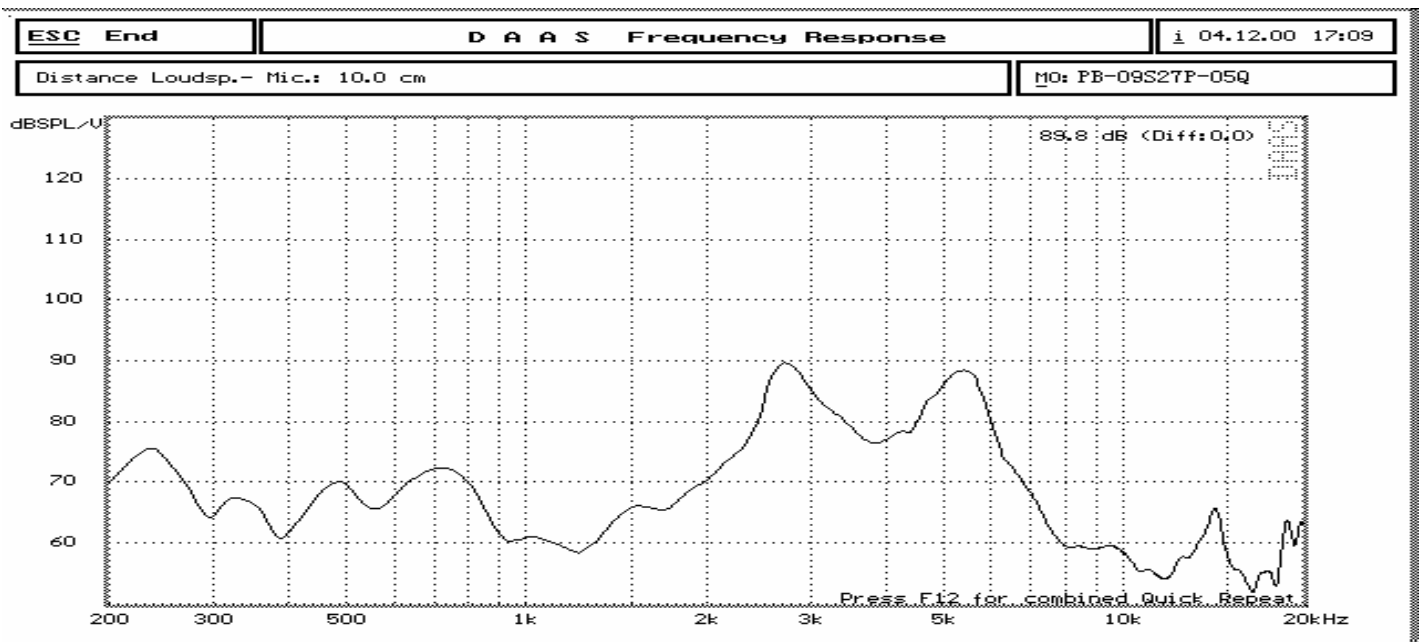

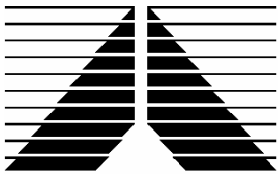

HITPOINT

3 . Dimensions and Material

3-1 Shape

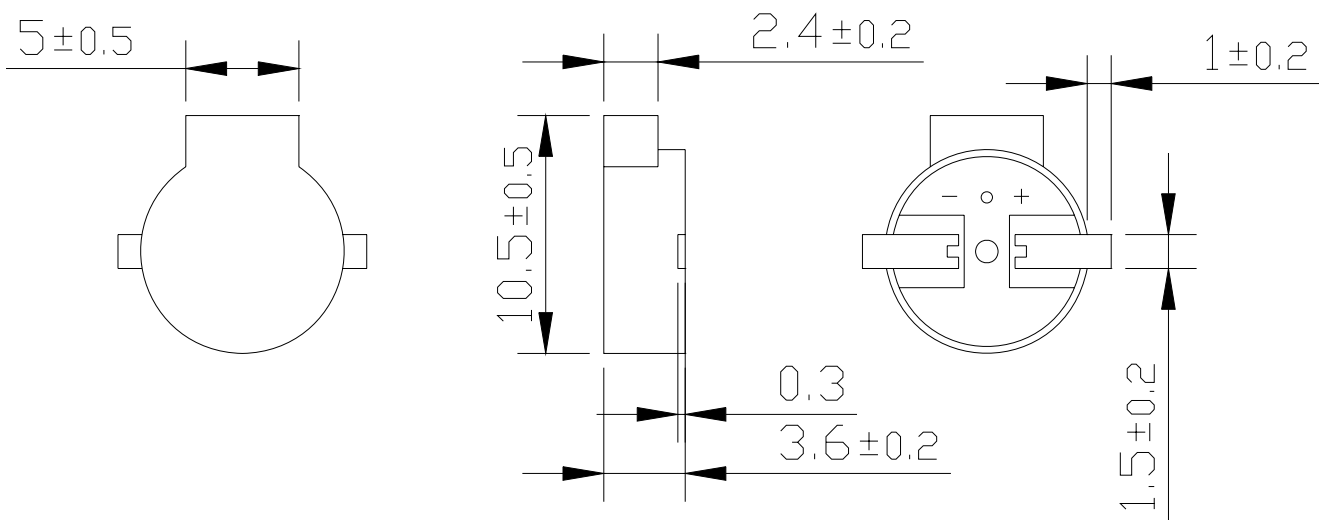

Unit : mm

3-2 Material

Housing	PPO1200 plastic resin (Color : Black)
Leading Pin	Tin Plated Brass
Weight (Gram)	0.4

4 . Recommend Driving Circuit

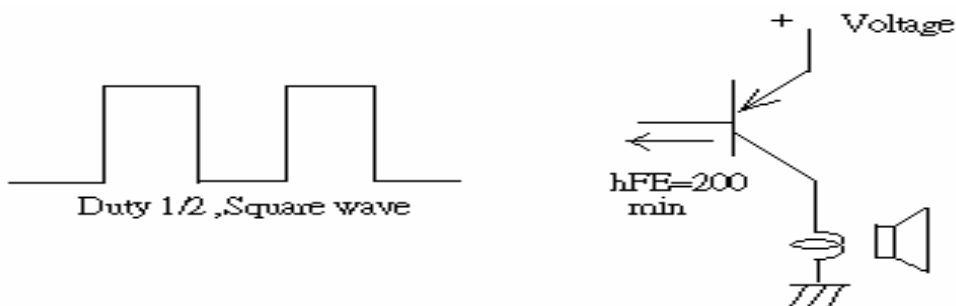

The base current I_b should high enough so that it saturates the collector current of the transistor with the CB load.



HITPOINT

5. TESTING METHOD

• *Standard Measurement conditions*

Temperature: 25 ± 2 °C Humidity: 45-60%

• *Acoustic Characteristics*

The oscillation frequency, current consumption and sound pressure are measured by the measuring instruments shown below.

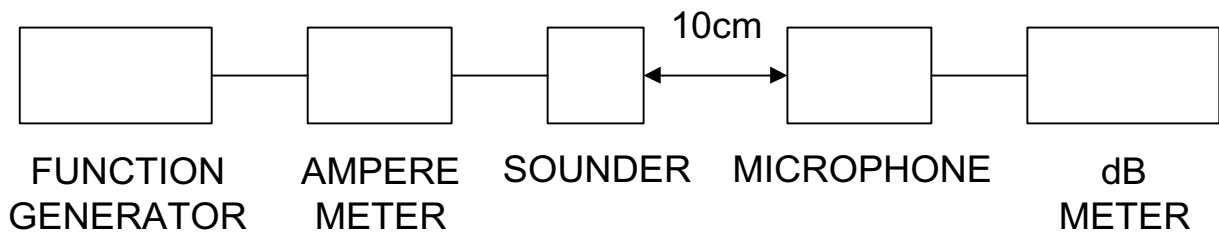

In the measuring test, buzzers is placed as follows:

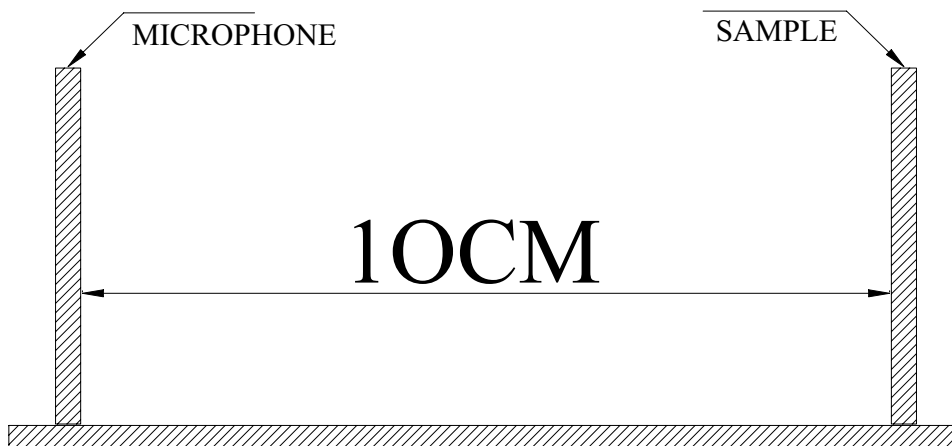

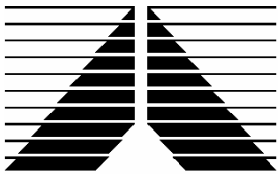

HITPOINT

6. RELIABILITY

ITEMS	METHOD OF TEST AND MEASUREMENTS	PERFORMANCE
<i>Coldness withstanding</i>	<i>After 98 hours of being exposed to -30 °C environment, should be returned to normal environment for 2 hours, then re-proceed to test.</i>	<i>No abnormality shall exist</i>
<i>Hotness withstanding</i>	<i>After 98 hours of being exposed to +80 °C environment, should be returned to normal environment for 2 hours, then re-proceed to test.</i>	<i>No abnormality shall exist</i>
<i>Humidity withstanding</i>	<i>After 98 hours of being exposed to 40 °C 95%RH environment in actual operation, should be returned to normal environment for 2 hours, then re-proceed to test.</i>	<i>No abnormality shall exist</i>
<i>Durability</i>	<i>Testing after 1,000 hours actual continuous operation. (at standard measurement conditions)</i>	<i>No abnormality shall exist</i>
<i>Drop withstanding</i>	<i>A natural drop from 75cm high down to the ground.</i>	<i>No abnormality shall exist</i>
<i>Vibration withstanding</i>	<i>Vibration of 2,000 cycles per minute, 2mm amplitude, applied in X, Y and Z directions for 30 minutes each.</i>	<i>No abnormality shall exist</i>

7. PACKAGE METHOD

< 1 > 100pcs per box , Total 10 boxes per carton , total 1000pcs carton;
Volume: L*W*H=510*330*300mm

< 2 > RoHS Mark

