

**Konektory krimpovací PAW, PXH, RM=4,20mm**

aktualizace: 11.12.2009

**PXH5150 , PAW4505 a PAWR4505**

rozteč pinů:	4.20mm	AC/DC max. napětí:	600V
počet pinů:	2 až 12	AC/DC max. proud:	6A
prac. teplota:	-40+105°C	zkušební napětí:	1500V AC / 1min
Ri:	>1000MΩ	dop.otvor v DSP	1.4mm
barva:	bílá	průřez vodiče:	AWG18+AWG24
povrch kontaktu:	Sn	vnější Ø izolace [mm]:	max ???
odpor kontaktu	10mΩ		

<b>Kcr</b>	<b>PAW4505</b>	<b>- 05</b>	<b>Sn</b>
série	typ	počet pinů	materiál pinů

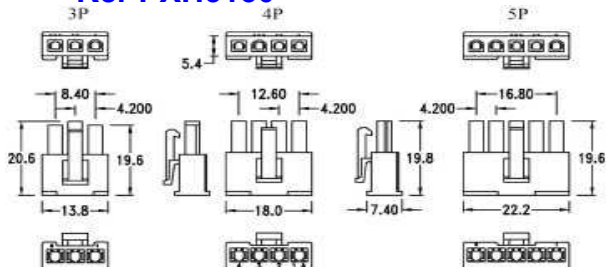
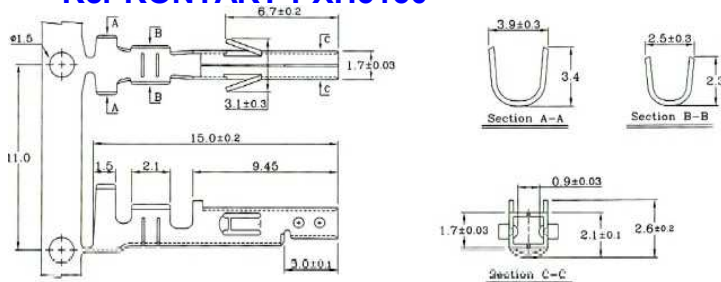
**Kcr PXH5150****Kcr KONTAKT-PXH5150**

objednáací název zásuvka	počet pinů	kontakt	protikus	
			vidlice - 180°	vidlice - 90°
Kcr PXH5150-02	02	Kcr KONTAKT-PXH5150	objednáací název	objednáací název
Kcr PXH5150-03	03		Kcr PAW4505-02	Kcr PAWR4505-02
Kcr PXH5150-04	04		Kcr PAW4505-03	Kcr PAWR4505-03
Kcr PXH5150-05	05		Kcr PAW4505-04	Kcr PAWR4505-04
Kcr PXH5150-06	06		Kcr PAW4505-05	Kcr PAWR4505-05
Kcr PXH5150-07	07		Kcr PAW4505-06	Kcr PAWR4505-06
Kcr PXH5150-08	08		Kcr PAW4505-07	Kcr PAWR4505-07
Kcr PXH5150-09	09		Kcr PAW4505-08	Kcr PAWR4505-08
Kcr PXH5150-10	10		Kcr PAW4505-09	Kcr PAWR4505-09
Kcr PXH5150-11	11		Kcr PAW4505-10	Kcr PAWR4505-10
Kcr PXH5150-12	12		Kcr PAW4505-11	Kcr PAWR4505-11
				Kcr PAW4505-12

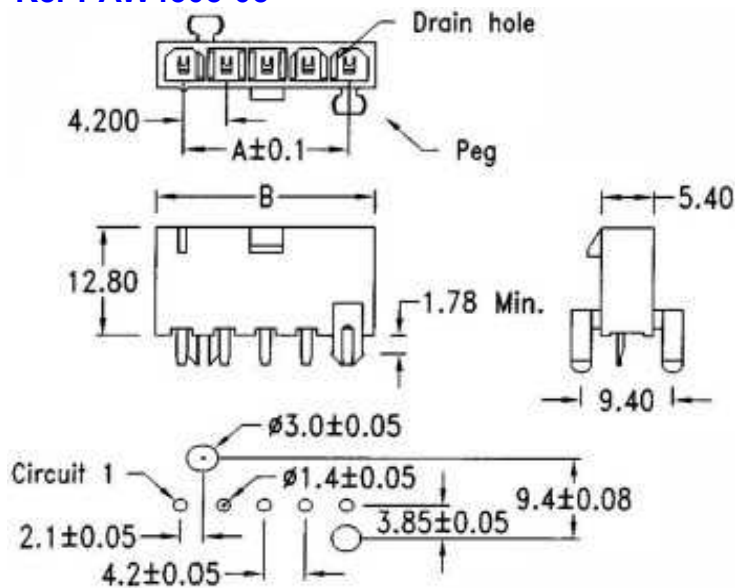
**Kcr PAW4505-05****Kcr PAWR4505-05**

A= N x 4.2mm

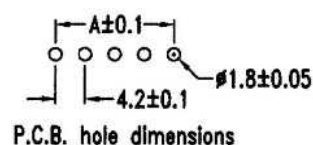
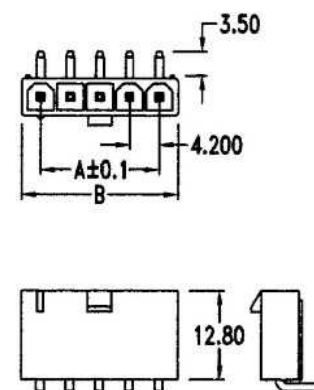

**Konektory krimpovací PAW, PXH, RM=4,20mm****PXH5150 , PAW4505 a PAWR4505 - dvouřadé**

rozteč pinů:	4.20mm	AC/DC max. napětí:	600V
počet pinů:	2 až 24	AC/DC max. proud:	9A
prac. teplota:	-40+105°C	zkušební napětí:	1500V AC / 1min
Ri:	>1000MΩ	dop.otvor v DSP	1.8mm
barva:	bílá	průřez vodiče:	AWG18+AWG24
povrch kontaktu:	Sn	vnější Ø izolace [mm]:	max ???
odpor kontaktu	10mΩ		

**Kcr PAWR4505S - 03x2 Sn**

série    typ    S-montážní úchyty    pinů v řadě    řad    materiál pinů

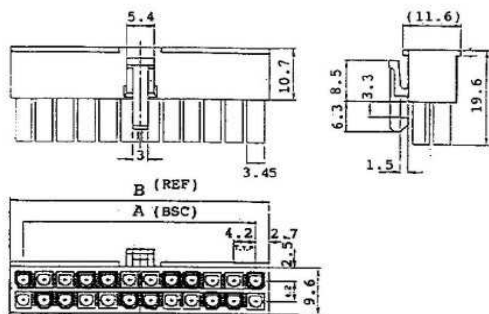
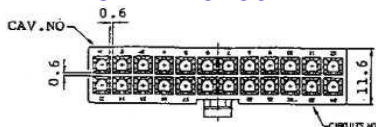
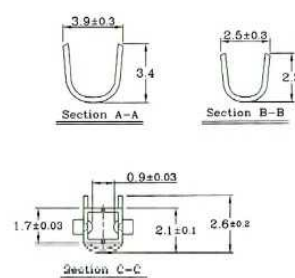
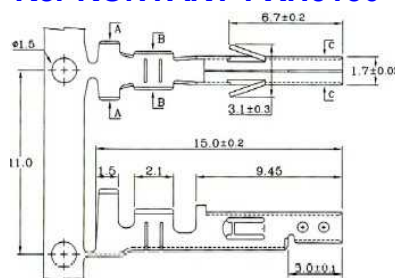
**Kcr PXH5150-12x2****Kcr KONTAKT-PXH5150**

objednáací název zásuvka	počet pinů	A (mm)	B (mm)	kontakt	protikus		
					vidlice - 90°	vidlice - 180°	vidlice - 90° s montáž. úchyty
					objednáací název	objednáací název	objednáací název
Kcr PXH5150-01x2	02		5.6	Kcr KONTAKT-PXH5150	Kcr PAWR4505-01x2	Kcr PAWR4505-01x2	Kcr PAWR4505S-01x2
Kcr PXH5150-02x2	04	4.2	9.8		Kcr PAWR4505-02x2	Kcr PAWR4505-02x2	Kcr PAWR4505S-02x2
Kcr PXH5150-03x2	06	8.4	14.0		Kcr PAWR4505-03x2	Kcr PAWR4505-03x2	Kcr PAWR4505S-03x2
Kcr PXH5150-04x2	08	12.6	18.2		Kcr PAWR4505-04x2	Kcr PAWR4505-04x2	Kcr PAWR4505S-04x2
Kcr PXH5150-05x2	10	16.8	22.4		Kcr PAWR4505-05x2	Kcr PAWR4505-05x2	Kcr PAWR4505S-05x2
Kcr PXH5150-06x2	12	21.0	26.6		Kcr PAWR4505-06x2	Kcr PAWR4505-06x2	Kcr PAWR4505S-06x2
Kcr PXH5150-07x2	14	25.2	30.8		Kcr PAWR4505-07x2	Kcr PAWR4505-07x2	Kcr PAWR4505S-07x2
Kcr PXH5150-08x2	16	29.4	35.0		Kcr PAWR4505-08x2	Kcr PAWR4505-08x2	Kcr PAWR4505S-08x2
Kcr PXH5150-09x2	18	33.6	39.2		Kcr PAWR4505-09x2	Kcr PAWR4505-09x2	Kcr PAWR4505S-09x2
Kcr PXH5150-10x2	20	37.8	44.1		Kcr PAWR4505-10x2	Kcr PAWR4505-10x2	Kcr PAWR4505S-10x2
Kcr PXH5150-11x2	22	42.0	47.6		Kcr PAWR4505-11x2	Kcr PAWR4505-11x2	Kcr PAWR4505S-11x2
Kcr PXH5150-12x2	24	46.2	51.8		Kcr PAWR4505-12x2	Kcr PAWR4505-12x2	Kcr PAWR4505S-12x2

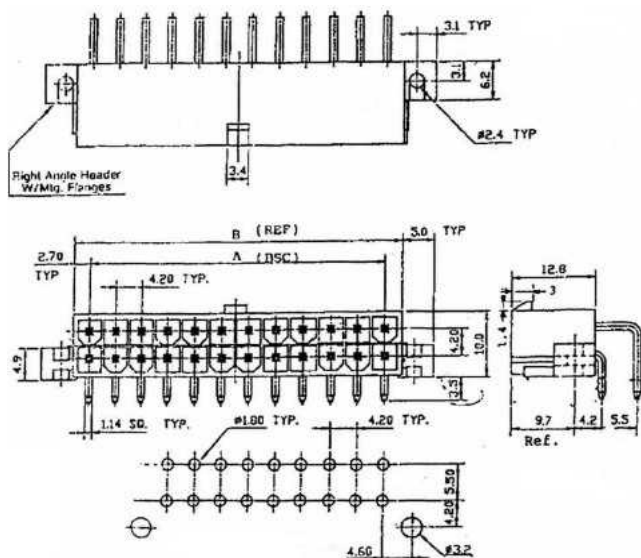
**Kcr PAWR4505S-12x2**

počet pinů	A(mm)	B(mm)
02		5.4
04	4.2	9.6
06	8.4	13.8
08	12.6	18.0
10	16.8	22.2
12	21.0	26.4
14	25.2	30.6
16	29.4	34.8
18	33.6	39.0
20	37.8	43.2
22	42.0	47.4
24	46.2	51.6

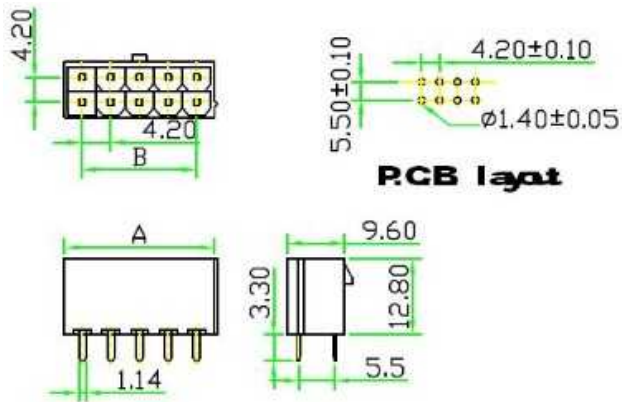
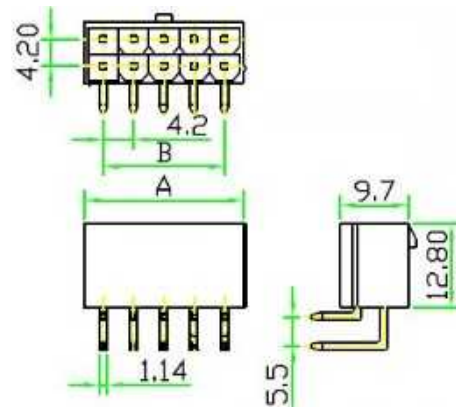
**Konektory krimpovací PAW, PXH, RM=4,20mm****Kcr PAW4505-05x2****Kcr PAWR4505-05x2**

**Konektory krimpovací PAW, PXH, RM=4,20mm****PXH5050 - protikus stejný jako k PXH5150 (výše)**

rozeč pinů:	4.20mm	AC/DC max. napětí:	600V
počet pinů:	2 až 24	AC/DC max. proud:	9A
prac. teplota:	-40-+105°C	zkušební napětí:	1500V AC / 1min
Ri:	>1000MΩ	dop.otvor v DSP	1.8mm
barva:	bílá	průřez vodiče:	AWG18÷AWG24
povrch kontaktu:	Sn	vnější Ø izolace [mm]:	max ???
odpor kontaktu	10mΩ		

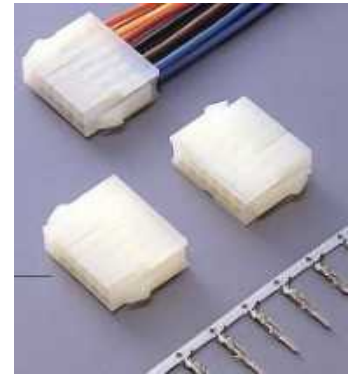

objednací název zásuvka	počet pinů	A (mm)	B (mm)	C (mm)	D (mm)	kontakt
Kcr PXH5050-01x2	02		5.4	5.8	10.8	Kcr KONTAKT-PXH5050
Kcr PXH5050-02x2	04	4.2	9.8	10.0	15.0	
Kcr PXH5050-03x2	06	8.4	13.8	14.2	19.2	
Kcr PXH5050-04x2	08	12.6	18.0	18.4	23.4	
Kcr PXH5050-05x2	10	16.8	22.2	22.0	27.6	
Kcr PXH5050-06x2	12	21.0	28.4	26.8	31.8	
Kcr PXH5050-07x2	14	25.2	30.8	31.0	36.0	
Kcr PXH5050-08x2	16	29.4	31.8	35.2	40.2	
Kcr PXH5050-09x2	18	33.0	39.0	39.4	44.4	
Kcr PXH5050-10x2	20	37.8	43.2	43.6	48.6	
Kcr PXH5050-11x2	22	42.0	47.4	47.8	52.8	
Kcr PXH5050-12x2	24	46.2	51.6	52.0	57.0	

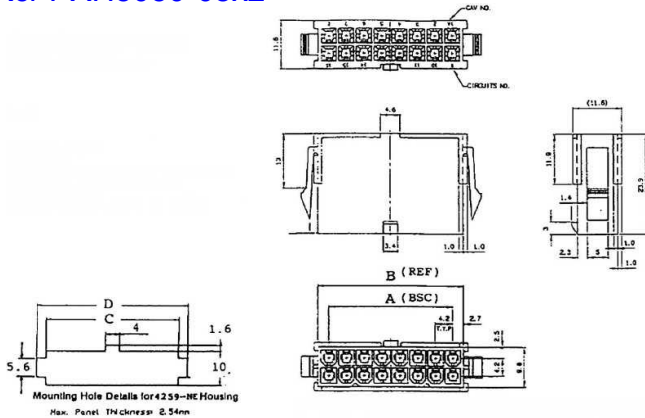
**Kcr PXH5050-08x2****Kcr KONTAKT-PXH5050**