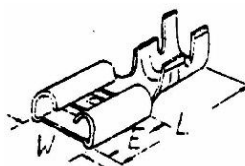

FASTON 4.8 VL 1663 Sn

typ	rozteč	materiál
V - vidlice	typové číslo	
Z - zásuvka		
VL - vidlice zahnutá		
ZL - zásuvka zahnutá		

Konektory FASTON - kabelové zásuvky

Objednávací název	vodič AWG	vodič mm ²	barva izolace	W (mm)	E (mm)	L (mm)
FASTON 4.8 Z 804211	AWG22-16	0.3-1.3	bez izolace	5.6	6.5	15.0
FASTON 4.8 Z 1741 CuSn			bez izolace			
FASTON 4.8 Z FH48 blue		1.5-2.5	modrá			
FASTON 4.8 Z FH48 red		1.5-2.5	červená			

**Konektory FASTON - kabelové vidlice**

Objednávací název	vodič AWG	vodič mm ²	barva izolace
FASTON V FS48x05RT	AWG22-18	0.3-1.0	červená
FASTON V FS48x05BL	AWG16-14	1.3-2.5	modrá
FASTON V FS48x08RT	AWG22-18	0.3-1.0	červená
FASTON V FS48x08BL	AWG16-14	1.3-2.5	modrá

**Konektory FASTON - vidlice do DPS**

materiál: mosaz

povrch: cín

Objednávací název	tloušťka	A(mm)	B(mm)	C(mm)	D(mm)	E(mm)	F(mm)	G(mm)	H(mm)	K(mm)	RM(mm)	ØX(mm)
FASTON 4.8 V 805203BL Sn	0.6	4.85	12.00	0.60	9.00	3.00	6.00	1.10	3.00	7.00	5.00	1.50
FASTON 4.8 V 805207BL Sn	0.8	4.85	12.00	0.80	9.00	3.00	6.00	1.24			5.00	1.50
FASTON 4.8 V 805206 Sn	0.8	4.8	12.00	0.80							5.00	
FASTON 4.8 V CC341 Sn	0.8	4.8	12.00	0.80							5.00	
FASTON 4.8 VL 805212BL Sn	0.8											
FASTON 4.8 VL LS1537 Sn	0.8											
FASTON 4.8 VL CC648 Sn	0.8											

FASTON 4.8 V 805203BL

FASTON 4.8 V 805207BL

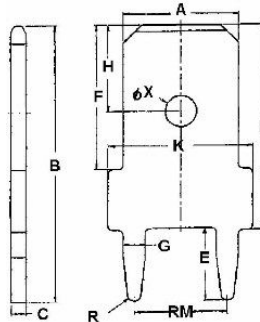

FASTON 4.8 V 805206 Sn



FASTON 4.8 V CC341 Sn

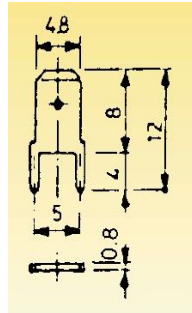

4E1B_2

FASTON Rm: 4.8mm

FASTON 4.8 VL 805212BL

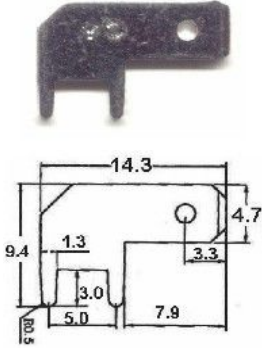

FASTON 4.8 VL LS1537

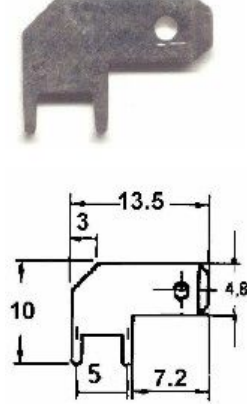

FASTON 4.8 VL CC648 Sn

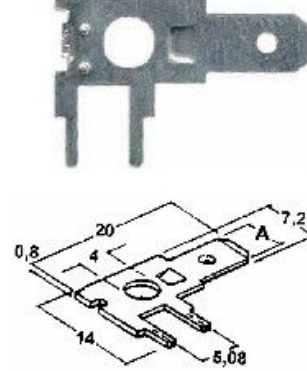

FASTON Rm: 4.8mm**Konektory FASTON - krytky**

Objednáací název	provedení	pro	D(mm)	W(mm)	E(mm)	L(mm)
FASTON 4.8 kryt P1741H	180°	zásuvku	2.50	5.80	16.00	23.00
FASTON 4.8 kryt KKM	180°	zásuvka		7.00	4.20	17.80
FASTON 4.8 kryt KKM-Z	180°	zásuvku	5.50	7.00	4.50	21.00

FASTON 4.8 kryt P1741H

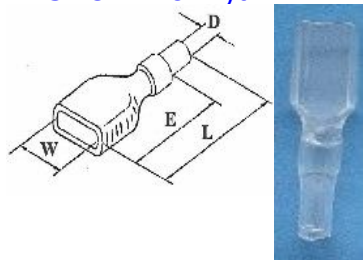

FASTON 4.8 kryt KKM

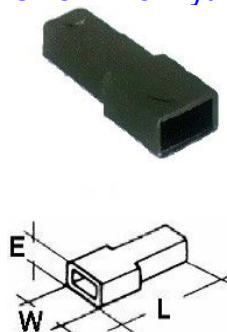

FASTON 4.8 kryt KKM-Z

